

# TEAC®

## Service Manual

---

# CTM5129STC

## 51cm Colour Television

---

## SPECIFICATION

SUPPLY VOLTAGE : AC220V 50Hz  $\geq + 10\%$  / -20%

MODEL : 14"

SYSTEM :	PAL - I / I	PAL - BG	PAL - I (UK)	PAL - SECAM - BG / DK	PAL - SECAM - BG / DK (HYPER)	PAL - BG (HYPER)	PAL - BG (CATV)	SECAM - L	L'	
CHANNEL L - VHF : H - VHF : UHF :	4 - 13 21 - 69	2 - 4 5 - 12 21 - 69	21 - 69	1 - 5 6 - 12 21 - 69	1 - 5 6 - 12 21 - 69	E2 - S10 E5 - S41 E21 - E69	E2 - S2 E5 - S20 E21 - E69	1 - Q 21 - 69	FB - FC	CH CH CH
VIF FREQUENCY :	38.9	38.9	39.5	38.0	38.9	38.9	38.9	38.9	32.7	MHz
SIF FREQUENCY :	32.9	33.4	33.5	31.5 32.5	32.4 33.4	33.4	33.4	32.4	39.2	MHz
CHROMA IF FREQUENCY :	34.47	34.47	35.07	33.57 33.57	34.47 34.47	34.47	34.47	34.47		MHz
INTER-CARRIER FREQUENCY :	6.0	5.5	6	6.5 5.5	6.5 5.5	5.5	5.5	6.5	6.5	MHz
SCANNING HORIZONTAL : VERTICAL :	15625 LINE 50 Hz									
ANTENNA INPUT IMPEDANCE :	75 OHM									
CRT :	14"									

<u>ITEMS OF MEASUREMENT</u>	<u>STANDARD</u>	<u>UNIT</u>
VIDEO SENS. AT S/N 30db L - VHF	≤ 57	dbuv
H - VHF	≤ 57	dbuv
UHF	≤ 60	dbuv
SOUND SENS. AT S/N 30db L - VHF	≤ 42	dbuv
H - VHF	≤ 42	dbuv
UHF	≤ 48	dbuv
AGC CHARACTER	≥ 60	db
SELECTIVITY -1.5 MHz	≥ 35	db
+ 8 MHz	≥ 40	db
COLOR SENS.	≤ 45	dbuv
COLOR LOCK - IN RANGE	≥ ±300	Hz
VERTICAL LOCK - IN RANGE	≥ 6	Hz
HORIZONTAL LOCK - IN RANGE	≥ 400	Hz
MAX BRIGHTNESS	≥ 140	cd / m2
MAX OUTPUT POWER	≥ 1	W
OUTPUT POWER AT 10% THD	≥ 0.7	W
BUZZ	≤ -40	db
AFC RANGE	≥ +1	MHz
	≥ -0.5	MHz
MIN. VOL HUM	≤ 20	mV
RESOLUTION HORIZONTAL	≥ 300	LINES
VERTICAL	≥ 400	LINES
LINEARITY DISTORTION VERTICAL	≤ 10	%
HORIZONTAL	≤ 10	%
RASTER DISTORTION	≤ 5	%
REMOTE CONTROL DISTANCE	≥ 5	METER
ANGLE	≥ ±15	DEGREE
POWER CONSUMPTION ( AT NORMAL CONDITION )	≤ 60	WATTS
POWER CONSUMPTION ( AT MAX. CONDITION )	≤ 70	WATTS
CONVERGENCE DISLOCATION AT AREA "A"	≤ 0.4	%
AREA "B"	≤ 0.8	%
( see fig.1 )		

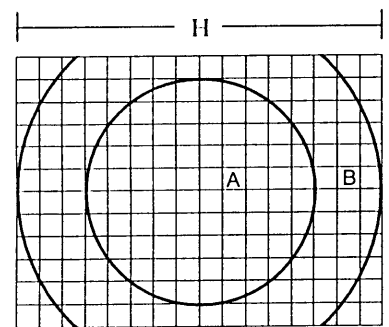

Fig.1

VIDEO INPUT LEVEL : 1.0V P-P ± 3dB  
 AUDIO INPUT LEVEL : 0.5V RMS ± 3dB

## SPECIFICATION

SUPPLY VOLTAGE : AC220V 50Hz  $\geq + 10\%$  /  $-20\%$

MODEL : 20" - 21"

SYSTEM :	PAL - I / I	PAL - BG	PAL - I (UK)	PAL - SECAM - BG / DK	PAL - SECAM - BG / DK (HYPER)	PAL - BG (HYPER)	PAL - BG (CATV)	SECAM - L	L'	
CHANNEL L - VHF : H - VHF : UHF :	4 - 13 21 - 69	2 - 4 5 - 12 21 - 69	21 - 69	1 - 5 6 - 12 21 - 69	1 - 5 6 - 12 21 - 69	E2 - S10 E5 - S41 E21 - E69	E2 - S2 E5 - S20 E21 - E69	1 - Q 21 - 69	FB - FC	CH CH CH
VIF FREQUENCY :	38.9	38.9	39.5	38.0	38.9	38.9	38.9	38.9	32.7	MHz
SIF FREQUENCY :	32.9	33.4	33.5	31.5 32.5	32.4 33.4	33.4	33.4	32.4	39.2	MHz
CHROMA IF FREQUENCY :	34.47	34.47	35.07	33.57 33.57	34.47 34.47	34.47	34.47	34.47		MHz
INTER-CARRIER FREQUENCY :	6.0	5.5	6	6.5 5.5	6.5 6.5	5.5	5.5	6.5	6.5	MHz
SCANNING HORIZONTAL : VERTICAL :	15625 LINE 50 Hz									
ANTENNA INPUT IMPEDANCE :	75 OHM									
CRT :	20" - 21"									

<u>ITEMS OF MEASUREMENT</u>	<u>STANDARD</u>	<u>UNIT</u>
VIDEO SENS. AT S/N 30db L - VHF	≤ 57	dbuv
H - VHF	≤ 57	dbuv
UHF	≤ 60	dbuv
SOUND SENS. AT S/N 30db L - VHF	≤ 42	dbuv
H - VHF	≤ 42	dbuv
UHF	≤ 48	dbuv
AGC CHARACTER	≥ 60	db
SELECTIVITY -1.5 MHz	≥ 35	db
+ 8 MHz	≥ 40	db
COLOR SENS.	≤ 45	dbuv
COLOR LOCK - IN RANGE	≥ ±300	Hz
VERTICAL LOCK - IN RANGE	≥ 6	Hz
HORIZONTAL LOCK - IN RANGE	≥ 400	Hz
MAX BRIGHTNESS	≥ 120	cd/m2
MAX OUTPUT POWER	≥ 1.8	W
OUTPUT POWER AT 10% THD	≥ 1.3	W
BUZZ	≤ -40	db
AFC RANGE	≥ +1	MHz
	≥ -0.5	MHz
MIN. VOL HUM	≤ 20	mV
RESOLUTION HORIZONTAL	≥ 300	LINES
VERTICAL	≥ 400	LINES
LINEARITY DISTORTION VERTICAL	≤ 10	%
HORIZONTAL	≤ 10	%
RASTER DISTORTION	≤ 5	%
REMOTE CONTROL DISTANCE	≥ 5	METER
ANGLE	≥ ±15	DEGREE
POWER CONSUMPTION (AT NORMAL CONDITION)	≤ 70	WATTS
POWER CONSUMPTION (AT MAX. CONDITION)	≤ 85	WATTS
CONVERGENCE DISLOCATION AT AREA "A"	≤ 0.4	%
AREA "B"	≤ 0.8	%
( see fig.2 )		

VIDEO INPUT LEVEL : 1.0V P-P ± 3dB  
 AUDIO INPUT LEVEL : 0.5V RMS ± 3dB

WOOFER AV INPUT LEVEL : 500 mV ± 50mV  
 FREQUENCY : 100Hz ± 10%

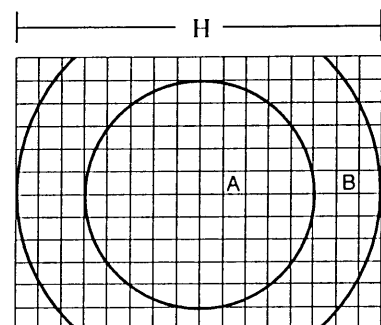
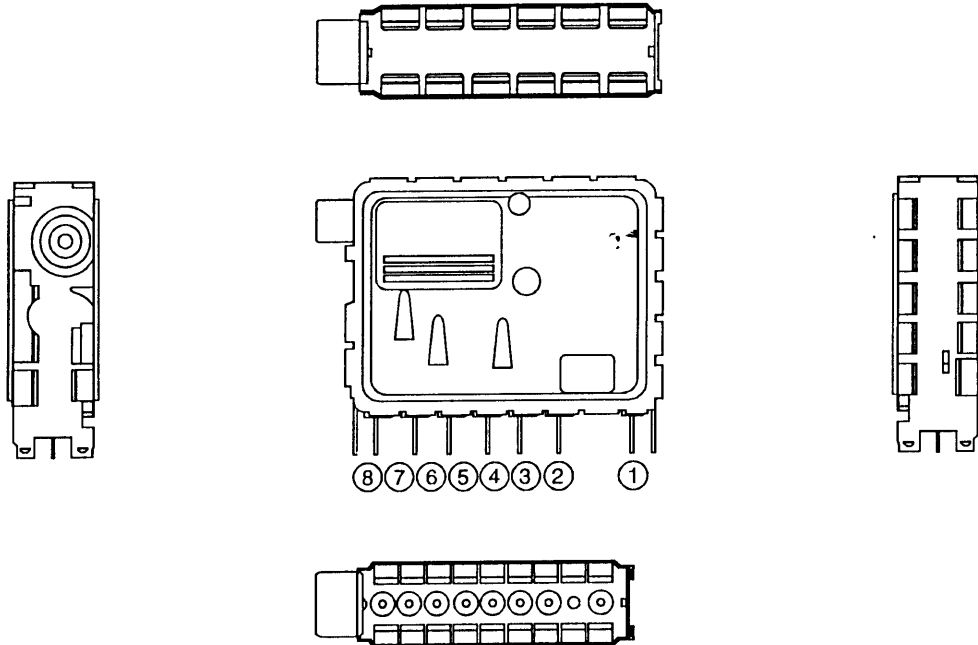

Fig.2

**PICTORIAL VIEW OF TUNER**

TERMINAL NO.	1	2	3	4	5	6	7	8
TERMINAL NAME	IF	B+	AFT	LB	AGC	HB	VT	UB



**PICTORIAL VIEW OF TUNER (WSP TUNER)**

TERMINAL NO.	1	2	3	4	5	6	7	8	9	10	11
TERMINAL NAME	AGC	VT	BU	BH	BL	B+	-	-	-	IF GND	IF

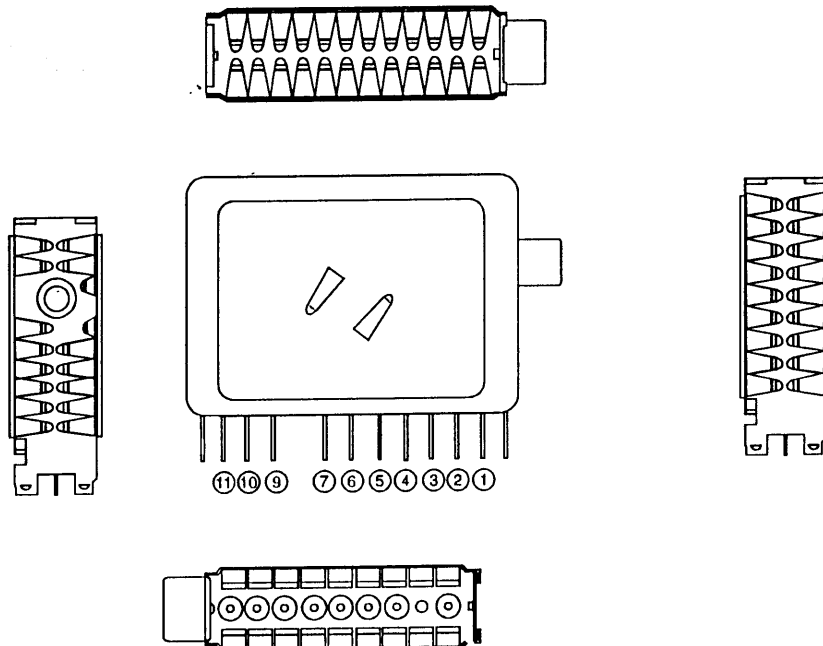

# ALIGNMENT INSTRUCTION

## I. PLEASE READ BEFORE ATTEMPTING SERVICE

1. Never disconnect any leads while receiver is in operation.
2. Disconnect all power before attempting any repairs.
3. Do not short any portion of the circuit while power is on.
4. For safety reasons, all parts replaced should be identical, (for parts and part numbers see parts list).
5. Before alignment the set must be pre-heated for 30 minutes or more and erase magnetism thoroughly from CRT front chassis frame by erase coil. (Except IF, SYNC, COLOR, SECAM, B+, SOUND)
6. An isolation transformer should be used during any dynamic service to avoid possible shock hazard.

## II. TEST EQUIPMENT

1. VIF Sweep Generator
2. SIF Sweep Generator
3. Colour Bar, Dot, Cross Hatch Generator
4. DC Power Supply
5. Oscilloscope
6. Vacuum Tube Voltmeter
7. Volt Ohmmeter
8. High Voltage Meter
9. Ampere Meter (0.5 Class, DC 3mA Max)
10. Demagnetizing Coil
11. Philips Pattern Generator
12. High Pot Tester

## III. VIF ALIGNMENT

### A. Preparation step. (see fig.3)

1. Connect Sweep Generator to tuner test point and Ground.
2. Connect 14V  $\pm$ 1V B+ Bias Voltage to C404 (-) and Ground.
3. Connect 14V  $\pm$ 1V B+ Bias Voltage to PIN3 at CN904 and Ground.
4. Connect A.G.C. Bias Voltage to PIN10 at IC102, TP105 the DC supply should be turned off this time.

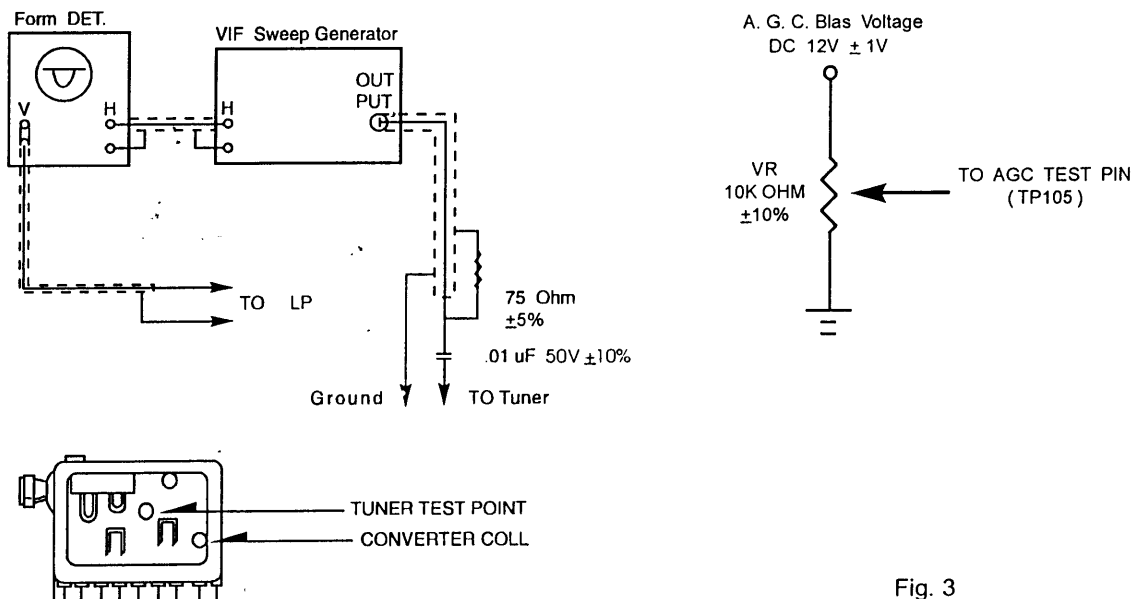

Fig. 3

B. VIF ALIGNMENT

1. Connect waveform detector to TP102 and Ground.
2. Connect 100ohm  $\pm 5\%$  resistor between TP103 and TP104.
3. Reduce output level of sweep generator to  $-50\text{dB} \pm 20\text{dB}$ .
4. Adjust A.G.C. bias to maintain the waveform achieve 1V p-p  $\pm 10\%$ .
5. Adjust tuner convertor coil to obtain the waveform as Fig.4.
6. If the tuner haven,t converter coil V.I.F. alignment may be omitted.

Remark : All frequency of market point can have  $+0.2\%$  tolerance.  
 (point (CC) and point (PC) can have  $\pm 0.25\text{div}$  tolerance)

SYSTEM	BG / DK, DK / I	I (UK)	I / I, BG BG / DK (W / H.P)
P.C. (MHz)	38.0	39.5	38.9

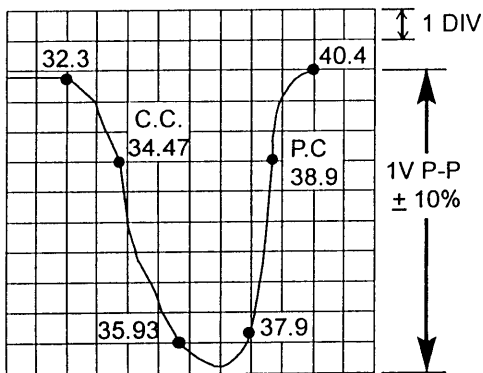

Fig.4

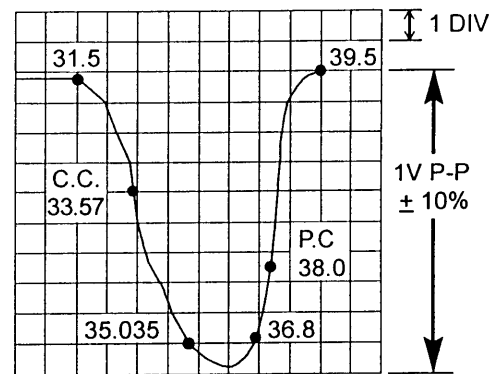

Fig.4

SYSTEM : PAL - I / I  
 PAL - BG  
 PAL - BG / DK  
 (W / HYPER BAND)

SYSTEM : PAL - DK / I

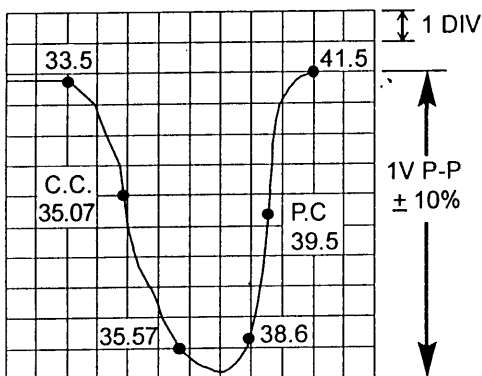

Fig.4

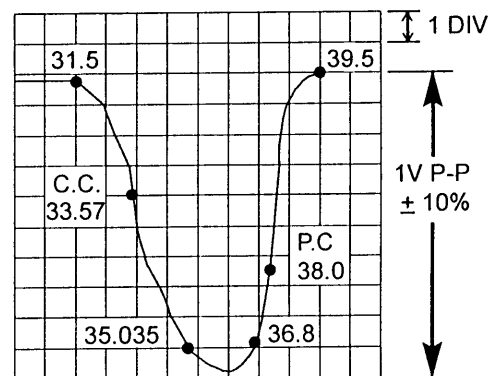

Fig.4

SYSTEM : PAL - I (UK)

SYSTEM : PAL - BG / DK  
 (W / O HYPER BAND)

REMARK : (C.C.) AND (P.C.) CAN HAVE  $\pm 1/4\text{DIV}$  TOLERANCE.



C. TANK COIL ALIGNMENT STEP ( see Fig. 5 )

1. Calibrate the Division of waveform Detector equal to 1V per div.
2. The output of sweep generator should be 40dB  $\pm$ 20dB.
3. Connect the waveform detector between TP106 and ground.
4. Connect the sweep generator to tuner test point and Ground.
5. Connect a 47K  $\pm$ 5% resistor between PIN7 to PIN22 at IC102.
6. Connect a 4K7 +5% resistor between PIN23 to Ground at IC102.
7. Adjust A.G.C. bias until the waveform just saturate.
8. Adjust T101 to obtain the waveform as Fig.5.
9. If the tuner haven't converter coil. Apply PAL I.F. signal ( 38.9MHz or 39.5mhz ) modulated with a colour bar pattern to tuner I.F. point.

REMARK : All frequency of marker point can have  $\pm$ 0.2% tolerance.

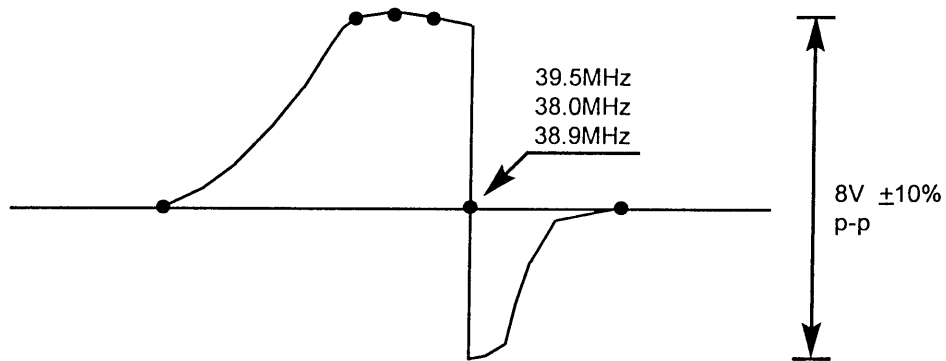

Fig. 5

SYSTEM	DK / I, BG / DK	I (UK)	BG, I / I, BG / DK (W / H.P.)
IF SIGNAL ( MHz )	38.0	39.5	38.9

Remark : VIF can have  $\pm$ 0.25V tolerance.

D. SIF ALIGNMENT ( Excluding DK / I )

MIXER ALIGNMENT

1. Connect a 47K  $\pm$ 5% resistor between PIN7 to PIN22 at IC102.
2. Connect a 4K7  $\pm$ 5% resistor between PIN23 to Ground at IC102.
3. Connect the sweep generator to TP102.
4. Connect the circuit as Fig.6 to TP107 and waveform detector.

Remark : All frequency .of marker point can have  $\pm$ 0.2% tolerance.

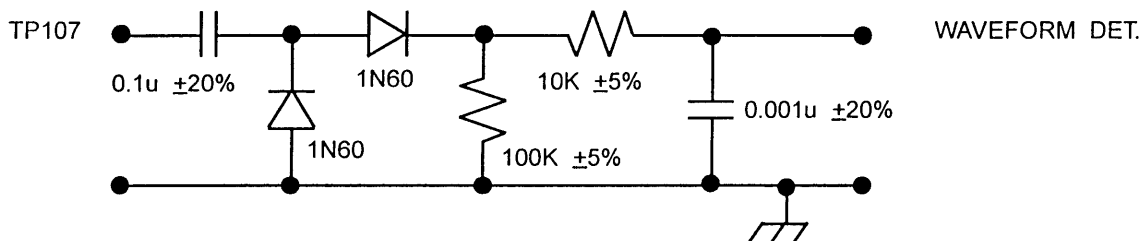
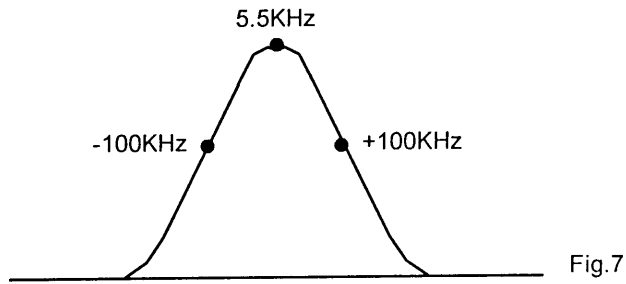

Fig.6

- Adjust the sweep generator output to obtain a maximum amplitude.
- Adjust T103 to obtain the waveform as Fig.7



#### SIG ALIGNMENT

- Connect a 47K  $\pm 5\%$  resistor between PIN7 to PIN22 at IC102.
- Connect a 4K7  $\pm 5\%$  resistor between PIN23 to Ground at IC102.
- Connect the sweep generator to TP102.
- Connect waveform detect to TP101.
- The output of sweep generator should be -30dB  $\pm 5$ dB.
- Adjust T104 to obtain the waveform as Fig.8.

Remark: All frequency of marker point can have  $\pm 0.2\%$  tolerance.

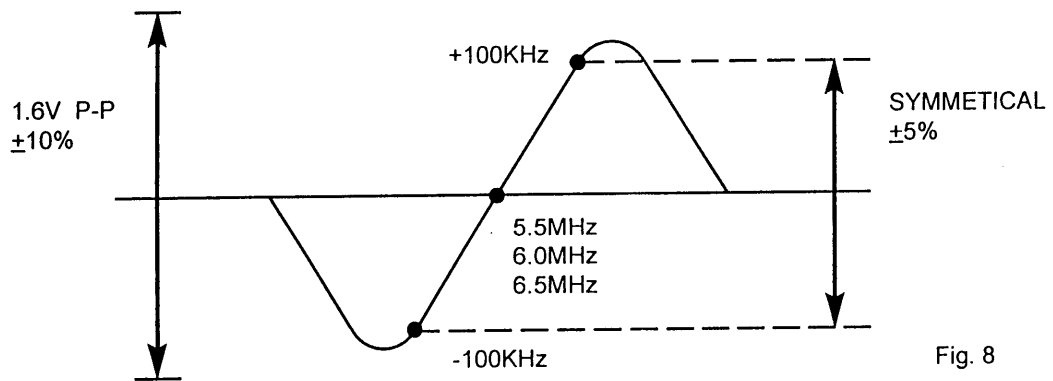

SYSTEM	DK / I	BG / DK	I / I	BG	DK
SIF (MHz)	6.0 6.5	5.5 6.5	6.0	5.5	6.5

### E. SIF ALIGNMENT (FOR STEREO)

1. Connect the sweep generator to TP105.
2. Connect waveform detect to PIN1 and PIN3 at CN306.
3. Connect A.G.C. Bias voltage to TP101.
4. The output of sweep generator should be  $-30\text{dB} \pm 5\text{dB}$ .
5. Adjust T104 and T102 to obtain the waveform as Fig.9.

Remark : All frequency of marker can have  $\pm 0.2\%$  tolerance.

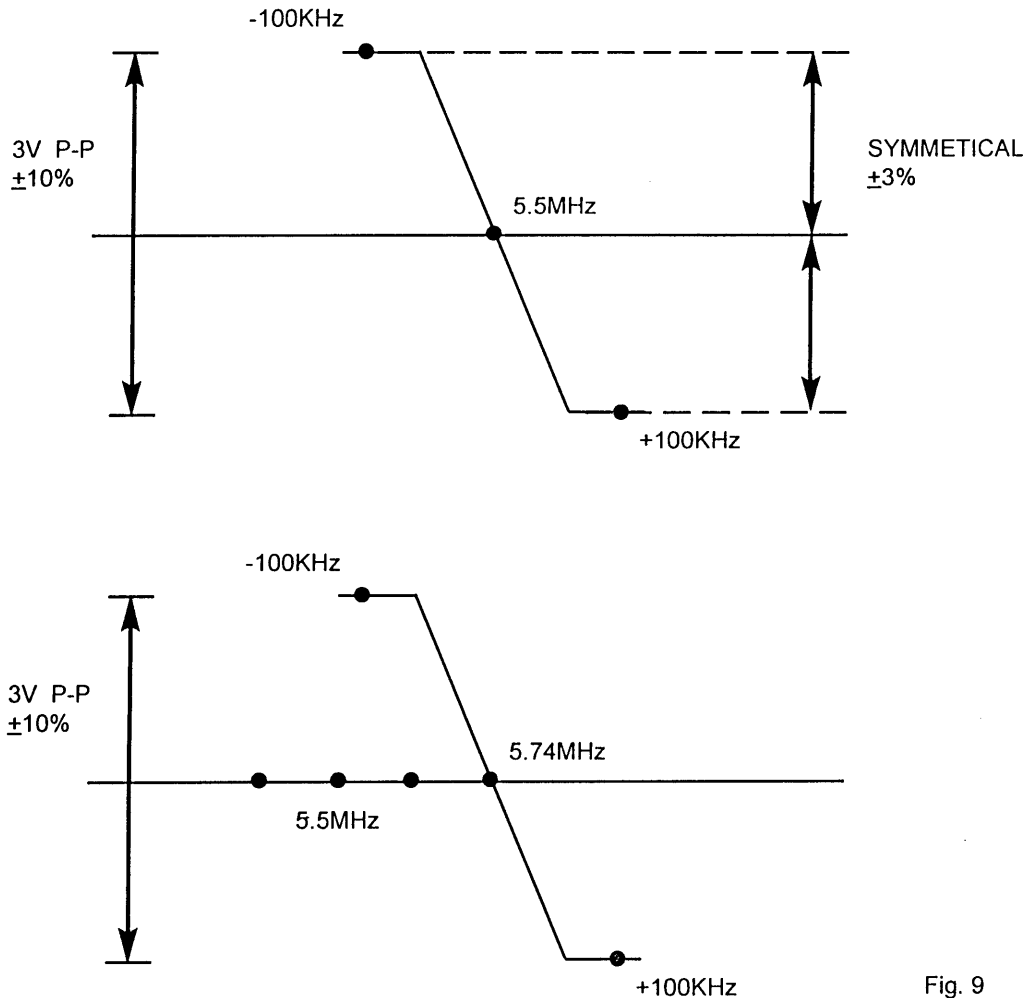

Fig. 9

### F. SOUND TANK COIL ALIGNMENT (FOR STEREO)

1. Connect Philips Pattern Generator to tuner test point and Ground. (Frequency is 38.9MHz color bar input signal is  $80\text{dB} \pm 3\text{dB}$ )
2. Connect Digital multimeter to PIN12 at IC101.
3. Adjust T103 to obtain a DC 2.8V  $\pm 0.1\text{V}$ .

### AFC ALIGNMENT (WHEN IC102 USE TDA8305 FOR PAL - DK / I)

1. Connect Philips Pattern Generator to tuner IF out and Ground. (Frequency is 38MHz color bar)
2. The output of Philips Pattern Generator should be  $80\text{dB} \pm 3\text{dB}$ .
3. Connect Digital multimeter to PIN18 at IC102.
4. Adjust T101 to obtain a DC 7V  $\pm 0.2\text{V}$ .

### G. PAL COLOUR ALIGNMENT

1. Receive Philips Pattern input signal 70dB  $\pm$ 10dB.
2. Connect Oscilloscope to TP305.
3. Set color control to middle position.
4. Adjust T301 and VR302 to obtain the waveform as Fig.10.

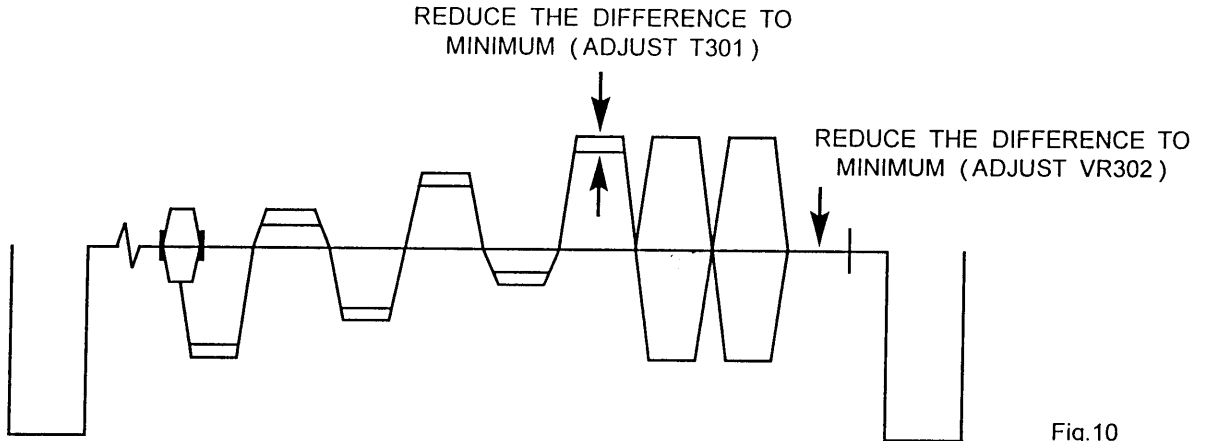

### COLOUR SYNC ADJUSTMENT

1. Receive Philips pattern (input signal is 70dB  $\pm$ 10dB).
2. Connect terminal IC302 PIN17 to GND and the earth with the short jumper wire.
3. Then the color striper appear on the screen when the adjustment is incorrect. Adjust the color sync (CT301) sothat the philips pattern stands till.

### NTSC TINT ALIGNMENT

1. Apply NTSC color bar to AV input.
2. Connect oscilloscope to TP302.
3. Set color control to middle position.
4. Adjust VR304 to obtain the waveform as Fig.11.

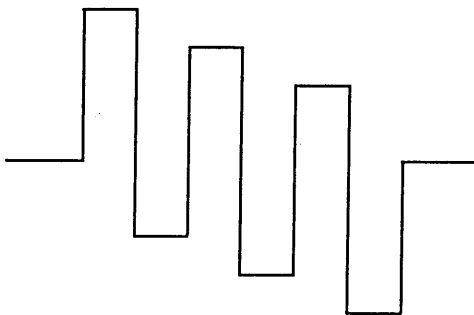

## H. B+ ADJUSTMENT

1. Connect a digital volt meter to TPB+ and ground.
2. Set Brightness, contrast and colour to minimum.
3. Adjust VR901 and obtain a reading of 111V  $\pm$ 1V.

## HORIZONTAL CIRCUIT ADJUSTMENT

1. Receive Monoscope Pattern input signal 70dB  $\pm$ 10dB.
2. Connect terminal 25 pin of IC102 and the ground with the Elect.Cap. 10 / 16  $\pm$ 20%.
3. Adjust VR103 to obtain the picture running at centre.
4. Adjust VR102 to obtain the picture at centre. ( specification show as below Fig.13 )

## VERTICAL CIRCUIT ADJUSTMENT

1. Receive the Monoscope Pattern input signal 70dB  $\pm$ 10dB.
2. Adjust V - size ( VR401 ) to obtain a normal picture.

## WHITE BALANCE ALIGNMENT STEP

( deguss the picture by deguassing coil if necessary )

1. Set the brightness, contrast, Screen and picture control to minimum value.
2. Set VR502, 504 to minimum position ( anti - clockwise ), set VR501, 503, 505 to middle position.
3. Receive a Monoscope or Philips Pattern input signal 70dB  $\pm$ 10dB.
4. Connect a digital meter between Red Gun and Ground on the CRT Board.
5. Adjust VR301 to obtain a CRT cut off voltage. ( 160V  $\pm$ 3V )
6. Adjust screen volume on FBT to brightest bar can just be screen.
7. Receive a black and white pattern input signal 70dB  $\pm$ 10dB or video input 1p-p  $\pm$ 3dB.
8. Set the brightness and contrast to middle position.
9. Adjust VR501, 502, 503, 504, 505 to obtain a uniformly white picture ( 9300°K ) +27M.P.C.D ( X=0.281, Y=0.311 ).

## SUB - BRIGHTNESS ALIGNMENT

1. Receive a Monoscope or Philips Pattern input signal 70dB  $\pm$ 10dB.
2. Set the brightness, contrast and colour to minimum.
3. Adjust VR301 until the brightest bar can just be screen.

## FOCUS ALIGNMENT

1. Set brightness and contrast to middle position.
2. Receive a monoscope pattern input signal 70dB  $\pm$ 10dB.
3. Adjust focus control to obtain sharpest picture.

## A.G.C. ALIGNMENT ( SEE FIG.12 )

1. Receive monoscope pattern at CH69 ( UHF ) and input field strength ( tuner input signal table show as below ).
2. Connect a digital meter between the tuner A.G.C. terminal and ground.
3. Adjust the A.G.C. variable resistor ( VR201 ) to the MAXIMUM position ( clockwise ), and then adjust the VR anti - clockwise until the voltage drop down  $\geq$ 0.4V.

TUNER MODEL NO.	RF INPUT SIGNAL(dB)	TUNER MODEL NO.	RF INPUT SIGNAL(dB)
ENV598B7F2	62±2dB	OSCAR 2900KKC	60±2dB
UVC6201-RC	57±2dB	HBC3300KHC	60±2dB
UVC8303-RW	57±2dB	TBD1CAB14	60±2dB
UVL1812-AW	57±2dB	TECC1986VA0618	60±2dB
UVC1401-EW	57±2dB	TBD1-HYPV15A	60±2dB
TDQ-5-32	57±3dB	UVE33-W24/R16-8649	60±2dB
TDQ 8-12	57±3dB	UVE50-AW04D	60±2dB
VISHZUZ51	60±2dB		

Fig. 12

DISTRICT	CENTRE (mm) POSITION	LIMIT (mm)	SCANNING SIZE (%)	SCANNING SIZE LIMIT (%)
THAILAND	-1	0 ~ -2	90	88 ~ 92
FRANCE	+3	0 ~ +5	90	88 ~ 94
GERMANY	+3	0 ~ +5	90	90 ~ 95
*GROUP A	-2	-5 ~ -1	90	88 ~ 94
*GROUP B	0	-2 ~ +2	90	88 ~ 94
*GROUP C	+3	0 ~ +5	90	88 ~ 94

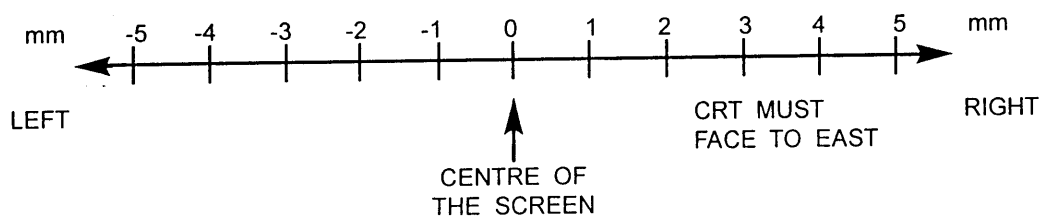

FIG. 13

- REMARK :
- SUITABLE FOR 14" OR ABOVE TV.
  - Adjust the centre position must take the upper side of monoscope pattern for standard.
  - Group A : AUSTRALIA, NEW ZEALAND, TAHITI.
  - Group B : HONG KONG, CHINA, AMERICA, CANADA, MALAYSIA, MEXICO.
  - Group C : ENGLAND, ITALY, GERMANY, RUSSIA, SWITZERLAND, JUGOSLAVIA, SPANISH.  
If the above countries are not include, please consult to Engineering Dept.

## I. SECAM COLOUR ALIGNMENT

### BELL FILTER ALIGNMENT

1. Receive secam color bar pattern input signal 70dB  $\pm$ 10dB.
2. Connect oscilloscope to TP303 through a 3K9  $\pm$ 5% resistor.
3. Turn T305 to obtain waveform as Fig.14.

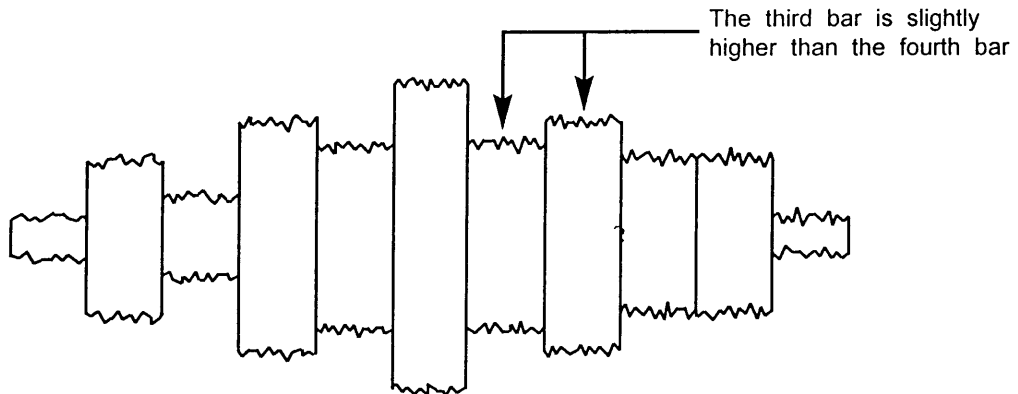

Fig.14

### SECAM COLOUR KILLER ALIGNMENT

1. Receive secam colour Bar signal input signal 70dB  $\pm$ 10dB.
2. Connect a DC digital meter to IC305 pin21.
3. Tune T304 to obtain a maximum voltage.  
"T302 (FOR NICAM, STEREO PCB) "

### DISCRIMINATOR ALIGNMENT

1. Receive secam colour Bar signal input signal 70dB  $\pm$ 10dB.
2. Connect the osillascope to TP301
3. Turn T303 to obtain the Fig.15.  
"T304 (FOR NICAM, STEREO PCB) "
4. Connect the osillascope to TP302.
5. Turn T302 to obtain Fig.16.  
"T303 (FOR NICAM, STEREO PCB) "

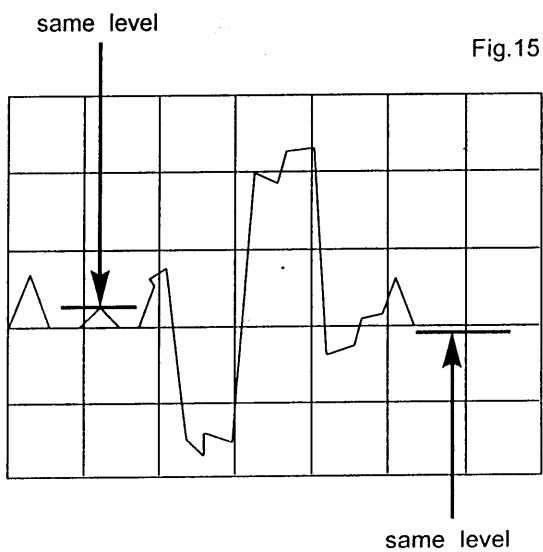

Fig.15

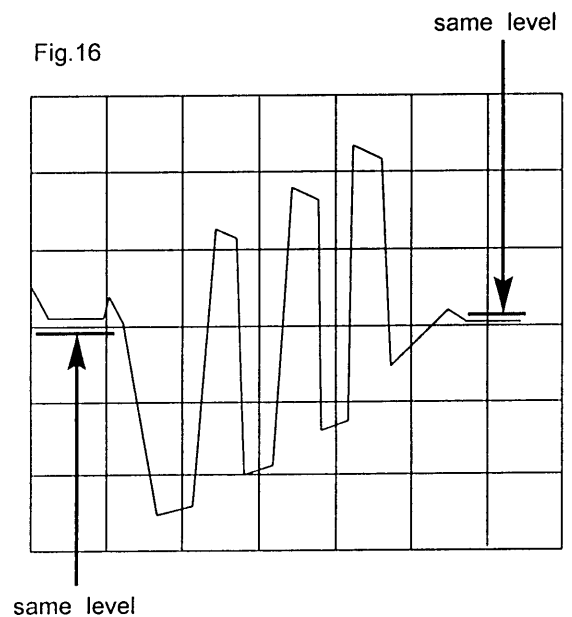

Fig.16

#### J. STEREO AND DUAL SOUND ALIGNMENT ( FOR STEREO )

1. Receive color bar pattern (with stereo and Dual Sound).
2. Connect oscilloscope to TP001 and TP002.
3. Adjust T001, VR001 and VR003 to obtain a maximum amplitude as Fig.17.

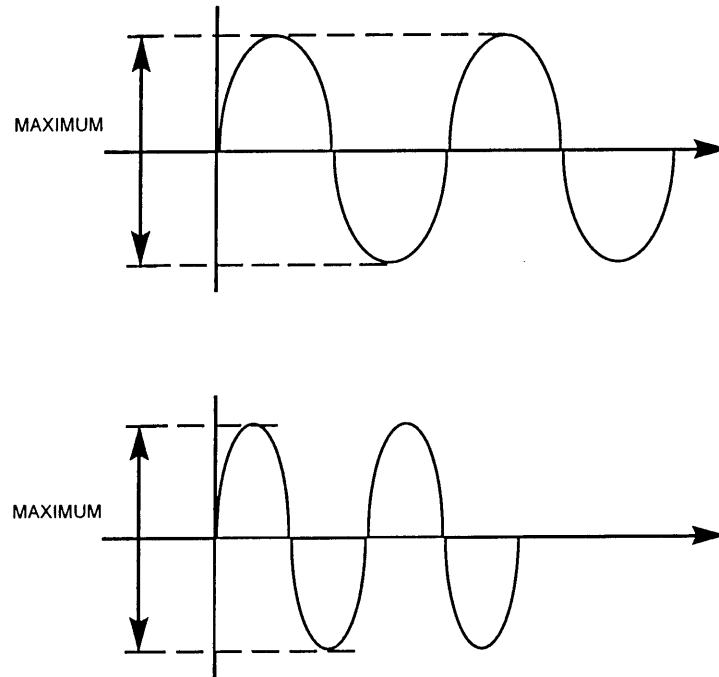

FIG.17

#### K. SEPARATION ALIGNMENT ( FOR STEREO )

1. Receive color bar pattern (with stereo sound, L3KHz R1KHz).
2. Connect oscilloscope to PIN1 at CN201 and ground.
3. Adjust volume control to maximum obtain a waveform no distortion.
4. Adjust VR002 to obtain a waveform as Fig.18.

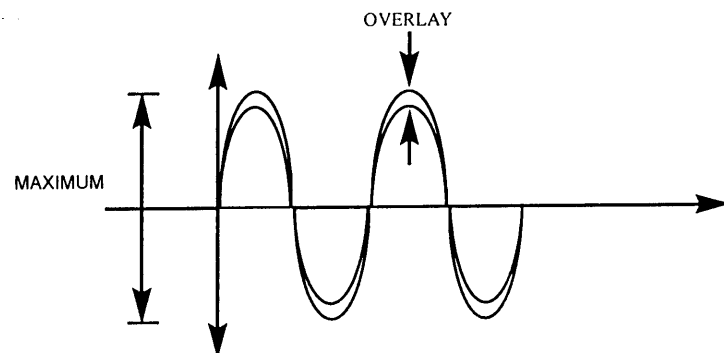

Fig.18



VOLTAGE TABLE FOR TRANSISTOR ( ONLY FOR REFERENCE )								
LOCATION \ TR	B (V)	C (V)	E (V)	LOCATION \ TR	B (V)	C (V)	E (V)	
Q101	12.2	0	12.2	Q602	0.7	0.06	0	
Q102	11.4	12.1	12.2	Q603	9.2	12.2	8.7	
Q103	0.02	12.2	0	Q604	0	0.24	0	
Q104	0.65	0.05	0	Q605	0.3	1.1	0	
Q105	1.13	8.5	0.4	Q901	9	19.7	8.4	
				Q902	7.9	0.07	2.3	
Q107	0.02	12.2	0	Q903	-0.07	2	0	
Q108	12.2	0	12.2	Q904	-1.69	258	0.6	
Q109				Q905	0.6	0.04	0	
Q110	1.4	9.6	0.7	Q906	109.5	110	110.1	
Q111	0.01	4.8	0	Q907	110	110.1	109.4	
Q112				Q501	3.13	134.2	2.6	
Q201	16.3	15.7	15.6	Q502	3.6	128.4	2.6	
Q301	0	2.9	0	Q503	3.1	127.4	2.6	
Q302	2.13	11.4	1.5					
Q303	0.06	6.28	0					
Q304	0.64	0.02	0					
Q305	0	1.9	0					
Q401	0.4	56.2	-0.01					
Q402	0.08	108.9	0					
Q601	0.6	2.01	0					

NOTE : VOLTAGE ARE TAKEN UNDER TUNED CONDITION WITH

CONTRAST : Maximum Position  
 BRIGHNESS : Maximum Position  
 COLOR : Maximum Position  
 SIGNAL INPUT : 70dB  $\pm$ 10dB  
 CHANNEL SETTING : The Last Channel of UHF High  
 SIGNAL PATTERN : Colour Bar

#### L. HIGH POT TESTING

1. Short the LINE CORD L - pole and N - pole.
2. Turn on the power switch of the TV set.
3. The High Pot Tester (-) connect to the L and N poly and (+) connect to the metal parts of cabinet.

Remark : The high pot tester can have  $\leq \pm 5\%$  tolerance.

SAFETY STD. \ CONDITION	TEST SYANDARD	TEST STANDARN FOR PRODUCTION
VDE, SAA	3.0KV 10mA / 1MIN	$\geq 3.5KV \leq 10mA / \geq 10 \text{ SEC.}$
BS	4.0KV 10mA / 1MIN	$\geq 4.0KV \leq 10mA / \geq 10 \text{ SEC.}$
CHINA STANDARD	3.0KV 10mA / 1MIN	$\geq 3.3KV \leq 5mA / \geq 6 \text{ SEC.}$

#### M. CONVERGENCE ADJUSTMENT ( SEE FIG.19 ) ( IF NECESSARY )

1. Receive a dotted pattern input signal  $70dB \pm 10dB$ .
2. Unfix the convergence magnet clamber and align red with blue dots at the center of the screen by rotating ( R,B ) static convergence magnets.
3. Align Red / Blue with green dots at the center of the screen by rotating ( RB - G ) static convergence magnet.
4. Fix the convergence magnets by turning the clamber.
5. Remove the DY wedges and slightly tilt the deflection yoke horizontally and vertically to obtain the good overall convergence.
6. Fix the deflection yoke by wedges.
7. If purity error is found, follow " PURITY ADJUSTMENT " INSTRUCTIONS.

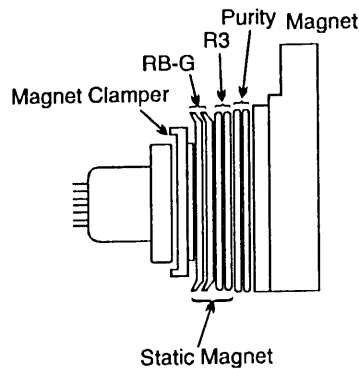

Fig. 19

VOLTAGE TABLE FOR TRANSISTOR ( ONLY FOR REFERENCE ) ( FOR STEREO )												
LOCATION \ TR		B (V)	C (V)	E (V)	LOCATION \ TR		B (V)	C (V)	E (V)			
Q001		2.1	7.6	1.4	Q302		0	1.9	0			
Q002		3.5	11.4	2.8	Q303		3.05	0	3.75			
Q003		1.8	3.4	1.1	Q401		0.4	60.0	-0.01			
Q004		2.5	5.3	1.8	Q402		-0.1	110.0	0			
Q005		3.7	11.4	3.0	Q601		0.6	2.01	0			
Q006		5.2	5.2	4.5	Q602		0.7	0.06	0			
Q007		0.08	5.2	0.3	Q603		9.2	12.2	8.7			
Q008		0.65	0.01	0	Q604		0	0.24	0			
Q009		0.55	0.01	0	Q605		0.3	1.1	0			
Q010		0.01	5.6	0.01	Q901		9	15.3	8.4			
Q101		10.2	10.9	11.1	Q902		6.4	-0.02	2.1			
Q102		11.1	0	11.1	Q903		-0.02	1.55	0			
Q103		0.65	0.04	0	Q904		2.48	264	0.1			
Q104		0.04	11.1	0	Q905		0.6	0.04	0			
Q105		1.10	7.3	0.4	Q906		109.5	110	110.1			
Q106		0	2.4	0	Q907		110	110.1	109.4			
Q107		0.04	11.1	0	Q501		3.13	134.2	2.6			
Q108		11.1	0	11.1	Q502		3.6	128.4	2.6			
Q109		3.5	11.1	2.8	Q503		3.1	127.4	2.6			
Q201		16.3	15.7	15.6	Q701		0	3	0			
Q301		0.04	2.53	0	Q702		3	-0.8	3			

NOTE : VOLTAGE ARE TAKEN UNDER TUNED CONDITION WITH

CONTRAST : Maximum Position  
 BRIGHNESS : Maximum Position  
 COLOR : Maximum Position  
 SIGNAL INPUT : 70dB  $\pm$ 10dB  
 CHANNEL SETTING : The Last Channel of UHF High  
 SIGNAL PATTERN : Colour Bar

VOLTAGE TABLE FOR IC ( ONLY FOR REFERENCES )						
PIN NO. / SYMBOL	IC601 (V)	IC102 (V)	IC301 (V)	IC302 (V)	IC303 (V)	IC304 (V)
1	4.33	5.4	0.09	3.6	5.1	3.4
2	0.82	2.9	0	GND	0	11.2
3	4.85	2.8	0	3.6	3.8	8.4
4	4.85	3.5	0	3.6	0	8.3
5	4.85	3.2	0	3.6	3.9	8.2
6	NC	GND	0	3.6	3.5	0.86
7	0.04	11.6	0	3.6	GND	0.1
8	0.02	5.6	0	0.01	GND	4.1
9	2.5	5.6	0	0.14	3.3	4.1
10	4.1	2.4	GND	0.02	3.8	4.1
11	GND	1.85	0.1	3	0.8	2.7
12	4.5	NC	0	0.02	5.1	3.1
13	5	3	0.1	3	5.1	NC
14	5	1.5	0	11.2	NC	3.9
15	5	NC	0.1	0.02	4.4	3.9
16	5	GND	0	3.0	9.8	2.6
17	5	3.5	0.09		3.4	1.9
18	0.1	5.0	0		9.5	GND
19	5	6.6	0.09		NC	3.4
20	5	5.6	5		3.1	3.4
21	GND	5.6			NC	
22	0	9.5			4.4	
23	0	2.8			GND	
24	0	2.8			5.1	
25	0	4.6				
26	0.4	0.8				
27	-0.02	0.8				
28	5	3.3				
29	4.6					
30	GND					
31	2.4	SYMBOL / PIN NO.	IC305 (V)	IC201 (V)	IC401 (V)	IC901 (V)
32	2.4					
33	5					
34	0.6					
35	4.9	1	7.4	1.2	1.2	10.6
36	4.9	2	7.4	0.01	GND	GND
37	0.02	3	GND	GND	1.3	5
38	GND	4	2.2	15.3	GND	
39	3.3	5	2.3	0.01	12.6	
40	2.8	6	8.0	1.2	25	
41	0.25	7	11.4	14.2	NC	
42	5	8	5.6	7.9	5.7	
43		9	3.2	15.2	24.6	
44		10	7.8	8.0		
45		11	2.9	14.2		
46		12	7.6	GND		
47		13	2.1			
48		14	7.1			
49		15	0.9			
50		16	NC			
51		17				

NOTE : VOLTAGE ARE TAKEN UNDER TUNED CONDITION WITH

CONTRAST : Maximum Position  
 BRIGHNESS : Maximum Position  
 COLOR : Maximum Position  
 SIGNAL INPUT : 70dB ±10dB  
 CHANNEL SETTING : The Last Channel of UHF High  
 SIGNAL PATTERN : Colour Bar

VOLTAGE TABLE FOR IC ( ONLY FOR REFERENCES ) ( FOR NICAM )						
PIN NO.	SYMBOL	IC005 ( V )	IC006 ( V )	IC007, IC008 ( V )	IC009 ( V )	IC010 ( V )
1		2.1	2.0	5.2	2.6	5.2
2		0.78	GND	1.4	2.6	NC
3		0.61	2.3	1.4	2.6	NC
4		0.61	5.3	GND	GND	5.2
5		0.61	3.9	5.2	5.2	GND
6		GND	4.0	5.2	1.4	5.2
7		GND	4.0	5.2	1.4	GND
8		GND	3.9	11.4	1.4	2.6
9		3.1	1.2			2.6
10		7.1	2.1			2.6
11		0.61	4.2			GND
12		2.1	5.3			GND
13		0.78	4.2			5.2
14		0.78	GND			GND
15		0.78	2.3			4.8
16		11.3	2.6			2.3
17			NC			2.2
18			NC			5.2
19			GND			2.6
20			3.3			NC
21						2.3
22						NC
23						5.2
24						NC
25						GND
26						NC
27						0.03
28						5.2
29						
30						
31						
32						
33						
34						
35						
36						
37						
38						
39						
40						
41						
42						
43						
44						
45						
46						
47						
48						
49						
50						

NOTE : VOLTAGE ARE TAKEN UNDER TUNED CONDITION WITH

CONTRAST : Maximum Position  
 BRIGHNESS : Maximum Position  
 COLOR : Maximum Position  
 SIGNAL INPUT : 70dB  $\pm$ 10dB  
 CHANNEL SETTING : The Last Channel of UHF High  
 SIGNAL PATTERN : Colour Bar

VOLTAGE TABLE FOR IC ( ONLY FOR REFERENCES ) ( FOR STEREO )					
PIN NO.	SYMBOL	IC001 ( V )	IC002 ( V )		
1		5.6	NC		
2		5.6	NC		
3		7.4	NC		
4		11.1	NC		
5		7.3	NC		
6		7.3	GND		
7		7.3	GND		
8		7.3	GND		
9		0.06	9.3		
10		NC	9.3		
11		5.6	GND		
12		GND	GND		
13		11.2	0.01		
14		9.2	11.2		
15		9.2	11.2		
16		GND	11.2		
17		5.0			
18		GND			
19		5.0			
20		NC			
21		NC			
22		5.5			
23		5.5			
24		5.5			
25		5.5			
26		5.5			
27		5.5			
28		7.2			
29					
30					
31					
32					
33					
34					
35					
36					
37					
38					
39					
40					
41					
42					
43					
44					
45					
46					
47					
48					
49					
50					

NOTE : VOLTAGE ARE TAKEN UNDER TUNED CONDITION WITH

CONTRAST : Maximum Position  
 BRIGHNESS : Maximum Position  
 COLOR : Maximum Position  
 SIGNAL INPUT : 70dB  $\pm$ 10dB  
 CHANNEL SETTING : The Last Channel of UHF High  
 SIGNAL PATTERN : Colour Bar

VOLTAGE TABLE FOR IC ( ONLY FOR REFERENCES ) ( FOR 1P.TEXT )					
PIN NO.	SYMBOL	IC801 ( V )			
1		5			
2		2.1			
3		3.56			
4		0.01			
5		GEN			
6		4.9			
7		2.2			
8		2.4			
9		2.5			
10		5.0			
11		GEN			
12		2.1			
13		5			
14		GEN			
15		0.42			
16		0.5			
17		0.4			
18		3.8			
19		4.5			
20		0			
21		NC			
22		NC			
23		NC			
24		3.2			
25		2.8			
26		NC			
27		NC			
28		NC			
29		NC			
30		NC			
31		NC			
32		NC			
33		NC			
34		NC			
35		NC			
36		NC			
37		NC			
38		NC			
39		NC			
40		NC			
41					
42					
43					
44					
45					
46					
47					
48					
49					
50					

NOTE : VOLTAGE ARE TAKEN UNDER TUNED CONDITION WITH

CONTRAST : Maximum Position  
 BRIGHNESS : Maximum Position  
 COLOR : Maximum Position  
 SIGNAL INPUT : 70dB  $\pm$ 10dB  
 CHANNEL SETTING : The Last Channel of UHF High  
 SIGNAL PATTERN : Colour Bar

VOLTAGE TABLE FOR IC ( ONLY FOR REFERENCES ) ( FOR F.TEXT, S.TEXT )						
PIN NO.	SYMBOL	IC801 (V)	IC802 (V)	IC804 (V)		
1		5	NC	GEN		
2		1.8	4.2	4.2		
3		1.9	2.2	4.3		
4		0.03	2.2	NC		
5		GEN	3.8	NC		
6		4.9	1.3	NC		
7		2.2	1.2	NC		
8		2.4	3.6	NC		
9		2.5	3.6	NC		
10		5.0	3.7	NC		
11		GEN	0	NC		
12		2.1	0.3	5.0		
13		5	4.2	GEN		
14		GEN	GND	GEN		
15		0.42	0.6	2.3		
16		0.5	0.5	2.0		
17		0.4	0.5	0		
18		3.8	0.3	GEN		
19		4.5	0.5	NC		
20		0.8	GND	NC		
21		2.5	4.2	NC		
22		NC	2.5	NC		
23		4.3	0.8	GEN		
24		4.3	0.8	NC		
25		GEN	0.8	NC		
26		0.5	5.0	GEN		
27		0.5	5.0	NC		
28		0.5	5.0	5.0		
29		0.3				
30		0.5				
31		4.2				
32		0.3				
33		0				
34		3.7				
35		3.6				
36		3.6				
37		1.2				
38		1.3				
39		3.8				
40		2.2				
41		2.2				
42		4.2				
43		4.2				
44		0.8				
45		0.8				
46		0.8				
47		2.5				
48		5.0				
49						
50						

NOTE : VOLTAGE ARE TAKEN UNDER TUNED CONDITION WITH

CONTRAST	:	Maximum Position
BRIGHTNESS	:	Maximum Position
COLOR	:	Maximum Position
SIGNAL INPUT	:	70dB $\pm$ 10dB
CHANNEL SETTING	:	The Last Channel of UHF High
SIGNAL PATTERN	:	Colour Bar



**MODEL NO.: CT-M5129STC Chassis type GT-821**  
**SYSTEM: PAL BG PLAYBACK AV IN / OUT CABLE TUNER**

Part Number	Description	Unit	Qty
10780045546	455K HZ RESONATOR "KYOCERA"	PC	1
11310100517	CARBON FILM RESISTOR 100 OHM 1/16W +-5%	PC	2
11310200517	CARBON FILM RESISTOR 1K OHM 1/16W +-5%	PC	1
11310300517	CARBON FILM RESISTOR 10K OHM 1/16W +-5%	PC	1
11310900517	CARBON FILM RESISTOR 1 OHM 1/16W +-5%	PC	1
11347300517	CARBON FILM RESISTOR 47K OHM 1/16W +-5%	PC	1
11368200517	CARBON FILM RESISTOR 6.8K OHM 1/16W +-5%	PC	1
12747604203	ELECT. CAP. 47 MFD 16V +-20%	PC	1
13060010100	INFRARED EMITTER EL-1L1 KODENSHI	PC	1
13121071919	TRANSISTOR 2SA719S FO SHAN	PC	1
13123094500	TRANSISTOR 2SC945 NEC	PC	1
13380301033	I.C. SAA3010T PHILIPS	PC	1
17272600099	BARE WIRE 54MM	M	0.1
190R63301P2	REMOTE P.C.B. (050896)	PC	1
51626040810	SELF-TAPPING SCREW 2.6 X 8 P/T (HARDEN)	PC	2
774R6330100	BATTERY SPRING (+VE)	PC	1
774R6330200	BATTERY SPRING (-VE)	PC	1
774R6330300	BATTERY SPRING (+-VE)	PC	1
81004110413	POLYBAG 4" X 11" X 0.04MM W/RE-CYCLING MARK	PC	1
849R6330100	KEY PAD {FULL 40 KEYS}	PC	1
892R6330107	DIAL KEY PLATE - W/FASTEXT/CCD /FINE-TUNE/EFFECT (15 KEYS)	PC	1
900R6330203	HANDSET TOP CABINET -MATT BLK. SPRAYED W/SILVER 8001C S.S.	PC	1
902R6330203	HANDSET BOTTOM CABINET - MATT BLACK SPRAYED	PC	1
910R6330170	HANDSET BATTERY DOOR - TEAC DESIGN(RC-695)(CT-M5129STC)BLK	PC	1
973R6330100	VOLUME/CHANNEL KNOB - MOULDED BLACK	PC	1
10539910308	FIXED INDUCTIVE COIL 3.9 UH +-10% (WITTIS)	PC	1
11310010517	CARBON FILM RESISTOR 10 OHM 1/4W +-5%	PC	1
11310110517	CARBON FILM RESISTOR 100 OHM 1/4W +-5%	PC	3
11310210517	CARBON FILM RESISTOR 1K OHM 1/4W +-5%	PC	6
11310310167	METAL FILM RESISTOR 10K OHM 1/4W +-1%	PC	1
11310310517	CARBON FILM RESISTOR 10K OHM 1/4W +-5%	PC	3
11315210517	CARBON FILM RESISTOR 1.5K OHM 1/4W +-5%	PC	2
11322310517	CARBON FILM RESISTOR 22K OHM 1/4W +-5%	PC	2
11327110517	CARBON FILM RESISTOR 270 OHM 1/4W +-5%	PC	1
11327310517	CARBON FILM RESISTOR 27K OHM 1/4W +-5%	PC	1
11333210517	CARBON FILM RESISTOR 3.3K OHM 1/4W +-5%	PC	2
11333310517	CARBON FILM RESISTOR 33K OHM 1/4W +-5%	PC	1
11339110517	CARBON FILM RESISTOR 390 OHM 1/4W +-5%	PC	1
11347110517	CARBON FILM RESISTOR 470 OHM 1/4W +-5%	PC	2
11347210517	CARBON FILM RESISTOR 4.7K OHM 1/4W +-5%	PC	2
11351210517	CARBON FILM RESISTOR 5.1K OHM 1/4W +-5%	PC	2
11356110517	CARBON FILM RESISTOR 560 OHM 1/4W +-5%	PC	1
11368110517	CARBON FILM RESISTOR 680 OHM 1/4W +-5%	PC	4
11368210517	CARBON FILM RESISTOR 6.8K OHM 1/4W +-5%	PC	1
12310034093	CERAMIC CAP. 10 PF 50V +-5% (NPO)	PC	1
12310427090	CERAMIC CAP. 0.1 MFD 25V +80 -20%	PC	9
12315034060	CERAMIC CAP. 15 PF +-5% (SL TYPE)	PC	1
12333034093	CERAMIC CAP. 33 PF 50V +-5% (NPO)	PC	2
12356135060	CERAMIC CAP. 560 PF 50V +-10% (SL TYPE)	PC	2
12610207101	MYLAR CAP. 0.001 MFD 50V +-10%	PC	1
12610407101	MYLAR CAP. 0.1 MFD 50V +-10%	PC	4
12622307101	MYLAR CAP. 0.022 MFD 50V +-10%	PC	1
12633207101	MYLAR CAP. 0.0033 MFD 50V +-10 %	PC	1
12668207101	MYLAR CAP. 0.0068 MFD 50V +-10%	PC	1
12668307101	MYLAR CAP. 0.068 MFD 50V +-10%	PC	1

**MODEL NO.:** CT-M5129STC Chassis type GT-821  
**SYSTEM:** PAL BG PLAYBACK AV IN / OUT CABLE TUNER

Part Number	Description	Unit	Qty
12710507203	ELECT. CAP. 1 MFD 50V +-20%	PC	1
12710704203	ELECT. CAP. 100 MFD 16V +-20%	PC	2
12733604203	ELECT. CAP. 33 MFD 16V +-20%	PC	1
13013414801	SILICON DIODE IN4148	PC	5
13121101500	TRANSISTOR 2SA1015 TOSHIBA	PC	1
13123181525	TRANSISTOR 2SC1815 TOSHIBA	PC	4
13310098833	I.C. CTV988V2.4 PHILIPS	PC	1
13310242131	I.C. ST24C02AB1 SGS	PC	1
13311528133	I.C. SAA5281P/E PHILIPS	PC	1
13330186648	I.C. Z86E0408PSC1866 "ZILOG"	PC	1
13338612948	I.C. Z86129 "ZILOG" FOR CCD	PC	1
13727000033	CRYSTAL 27 MHZ 16PF "GIC"	PC	1
13780000020	CRYSTAL 8.0 MHZ KITRONICS	PC	1
16010225527	PIN CONNECTOR 2 PINS PLUG	STRAIGHT (UL) (S.H.S)	PC 1
16010325527	PIN CONNECTOR 3 PINS PLUG		PC 2
16010625527	PIN CONNECTOR 6 PINS WAFER	(SHS) S11-W	PC 1
16138180222	I.C. SOCKET 18 PINS	#09-01-0018 "WELFARE"	PC 2
17272600099	BARE WIRE 54MM	M	1
19093290305	TELETEXT P.C.B (271297)	PC	1
19120004409	2 PIN SOCKET ASSM'Y L=440MM	PC	1
19130121407	3 PIN SOCKET ASS'Y L=240MM	PC	1
19130121507	3 PIN SOCKET ASS'Y L=460MM	PC	1
19130124610	3 PIN L=240MM UL2468 #26 (FLAT	CABLE) MALE/FEMALE BLACK	PC 0
19160120307	6 PIN SOCKET ASS'Y L=460MM		PC 1
51430340810	SELF-TAPPING SCREW 3 X 8 B/T	(HARDEN)	PC 1
58010126101	CABLE TIE L=100MM		PC 1
76293200100	MOUNTING CLIP		PC 1
51440031210	SELF-TAPPING SCREW 4 X 12 B/A	(HARDEN)	PC 1
51440042510	SELF-TAPPING SCREW 4 X 25 B/T	(HARDEN)	PC 2
51530340810	SELF-TAPPING SCREW 3 X 8	W/B/T (HARDEN)	PC 11
51530341010	SELF-TAPPING SCREW 3 X 10	W/B/T (HARDEN)	PC 4
51630041510	SELF-TAPPING SCREW 3 X 15 P/T	(HARDEN)	PC 1
51650043510	SEIF-TAPPING SCREW 5X35 P/T	(HARDEN) HEAD DIA. 9.5MM MAX	PC 4
52493250100	CRT MTG. SCREW 7 X 35 VP	(HARDEN)	PC 4
62288280200	FELT L240 X W17 X T0.5MM	W/TAPE	PC 8
77792130100	POWER KNOB SPRING	(ID=9MM,L=10MM)	PC 1
81005220414	POLYBAG 5" X 22" X 0.04MM	W/RE-CYCLING MARK {P/O MAT}	PC 1
81009150413	POLYBAG 9" X 15" X 0.04MM W/	RE-CYCLING P.E.MARK	PC 1
83423080100	RUBBER WASHER OD=23 , ID=8 ,	T=1.0	PC 2
83423080200	RUBBER WASHER OD=23, ID=8, T=2		PC 6
83423080500	RUBBER WASHER OD=23 ID=8 T=0.5		PC 2
84001102421	PAD CORD L240 X W10 X T1 MM	W/TAPE	PC 6
84005102011	RUBBER PAD (UL 94VO)		PC 3
93994210100	POWER KNOB ADAPTOR		PC 1
95488210000	AC LINE CORD CLIP		PC 1
95488280400	HIGH VOLTAGE CABLE SPACER		PC 2
00212100946	21" CRT (S/H) #A51KQK63X02	SAMSUNG	PC 1
00313137207	TUNER OSCAR 2900KKC 3X1 772	"TELEFUNKEN" (HIGH JACK)	PC 1
10710550066	SOUND TRAP CERAMIC FILTER	5.5MHZ WEI HAW	PC 1
10730550016	SOUND BYPASS CERAMIC FILTER	5.5MHZ WEI HAW	PC 1
10730574016	SOUND BYPASS CERAMIC FILTER	5.74MHZ SFE-5.74MC MURATA	PC 1
10773150000	SAW FILTER TSB-5308U (SANYO)		PC 1
10773891600	SAW FILTER TSF-5316 SANYO		PC 1
11315310517	CARBON FILM RESISTOR 15K OHM	1/4W +-5%	PC 2
11322310167	METAL FILM RESISTOR 22K OHM	1/4W +-1%	PC 1

**MODEL NO.:** CT-M5129STC Chassis type GT-821  
**SYSTEM:** PAL BG PLAYBACK AV IN / OUT CABLE TUNER

Part Number	Description	Unit	Qty
13310242131	I.C. ST24C02AB1 SGS	PC	1
17155008400	7' AC LINE CORD W/7.5A PLUG (DOUB.INSULATION)2 PIN SAA APP	PC	1
17262000540	UL 1007 TOP COAT WIRE AWG 20 50MM BLACK 5 X 5MM	PC	1
17272600099	BARE WIRE 54MM	M	0.1
18622750314	BATTERY 3A	PC	2
51530340810	SELF-TAPPING SCREW 3 X 8 W/B/T (HARDEN)	PC	1
6109421011B	GIFT BOX - TEAC (A) DESIGN (CT-M5129STC)	PC	1
66323006498	SERIAL NO.LABEL - OC:GT-064/98	PC	2
669821B0103	RATING LABEL - TEAC (A) DESIGN (CT-M5129STC)	PC	1
670821B0004	I/MANUAL - TEAC DESIGN (CT-M5129STC)	PC	1
678821B0105	SCREEN STICKER - TEAC DESIGN (A) (CT-M5129STC)	PC	1
678821B0201	CARTON LABEL - TEAC DESIGN	PC	2
678821B0202	CB NO.LABEL(I)-TEAC (A) DESIGN (CT-M5128TXT)(LARGE SIZE)	PC	2
678825B0201	EASY TUNE CARD (A1) - TEAC DESIGN	PC	1
67893131503	TOTAL CARE LABEL - TEAC (A) DESIGN	PC	1
69093293901	WARRANTY CARD -TEAC (B) DESIGN	PC	1
693821B0101	EAN CODE LABEL - 9313060009472	PC	1
703821B0102	SPEAKER GRILLE(0.8 THK í1.4 HOLE) - METALLIC GREY (8403C)	PC	2
71094210201	NAME PLATE - TEAC (B) DESIGN (ELECTROFORMED)	PC	1
800821B1100	POLYFOAM (B) - TOP LEFT	PC	1
800821B1200	POLYFOAM (B) - TOP RIGHT	PC	1
800821B1300	POLYFOAM (B) - BOTTOM LEFT	PC	1
800821B1400	POLYFOAM (B) - BOTTOM RIGHT	PC	1
81040400462	POLYBAG 40"X40"X0.04MM W/PUNCH [TEAC DESIGN (CT-M4895)]	PC	1
82630160500	FOAM SHEET 30" X 16" X 0.5MM THK.	PC	1
82634200500	FOAM SHEET - 34" X 20" X 0.5MM	PC	1
88488202002	JACK COVER-TEAC DESIGN WHI SS. W/21 PIN SOCKET HOLE	PC	1
88994210100	AV COVER PLATE (UL)	PC	1
900821B0104	FRONT CABINET (B) - METALLIC GREY (8403C)	PC	1
902942111U0	BACK CABINET W/O WOOFER (UL)	PC	1
917821B1107	FUNCTION LENS -TEAC (A) DESIGN (CT-M5129STC)W/CLEAR FUNCTION	PC	1
977821B0100	FUNCTION KNOB (FOR AUTO TUNNING FUNCTION)	PC	1
977821B0200	FUNCTION KNOB (FOR VOLUME CHANNEL FUNCTION)	PC	1
991821B0101	POWER KNOB - METALLIC GREY (8403C)	PC	1
00122002707	FLYBACK TRANSFORMER FCM20B027 SAMSUNG	PC	1
00855021105	DEGAUSSING COIL 60T (W/FIVE LAYERS OF TAPE)	PC	1
01210234006	SEMI-FIXED RESISTOR EVND8AA 03B13 1KB	PC	2
01210334006	SEMI-FIXED RESISTOR EVND8AA 03B14 10KB	PC	1
01210434006	SEMI-FIXED RESISTOR EVND8AA 03B15 100KB	PC	1
01230133006	SEMI-FIXED RESISTOR EVND2AA 03B32 300B	PC	2
01250134006	SEMI-FIXED RESISTOR EVND 8AA 03B52 500B	PC	1
01250233006	SEMI-FIXED RESISTOR EVND2AA 03B53 5KB	PC	3
01250234006	SEMI-FIXED RESISTOR EVND8AA 03B53 5KB	PC	1
01250334006	SEMI-FIXED RESISTOR EVND8AA 03B54 50KB	PC	2
01310000103	GLASS DELAY LINE YTS-8B WITTIS	PC	1
01320000500	Y-DELAY LINE YBL50F18X	PC	1
10119100596	HORIZONTAL DRIVE TRANSFORMER R1005	PC	1
10128882095	LINE FILTER 70MH	PC	1
10141021494	SWITCHING POWER TRANSFORMER KB40C214D (HIGHLIGHT)	PC	1
10237060002	TANK COIL / AFC COIL COILS 707851	PC	2
10267130002	SOUND IF COIL. COILS 710256	PC	2
10277020002	SECAM COLOR PAL DELAY LINE MATCHING COILS 707850	PC	1
10510010302	FIXED INDUCTIVE COIL 10uH +-10% AXIAL TYPE	PC	1
10510010308	FIXED INDUCTOR COIL 10 UH +-10% AXIAL	PC	1
10515010102	FIXED INDUCTIVE COIL 15UH 10%	PC	1

**MODEL NO.: CT-M5129STC Chassis type GT-821**  
**SYSTEM: PAL BG PLAYBACK AV IN / OUT CABLE TUNER**

Part Number	Description	Unit	Qty
10520110606	CHOKE COIL 200UH HIGHLIGHT	PC	1
10547910308	FIXED INDUCTIVE COIL 4.7 UH	PC	1
10556010308	FIXED INDUCTIVE COIL 56 UH	PC	1
10565015213	LINEARITY COIL 65UH "LI TONE"	PC	1
10568910308	FIXED INDUCTOR COIL 6.8 UH	PC	1
10582810302	FIXED INDUCTIVE COIL 0.82UH	PC	1
10582910308	FIXED CONDUCTOR COIL 8.2 UH	PC	3
10582910310	FIXED INDUCTIVE COIL 8.2UH	PC	1
11310010517	CARBON FILM RESISTOR 10 OHM	PC	5
11310110517	CARBON FILM RESISTOR 100 OHM	PC	8
11310110517	CARBON FILM RESISTOR 100 OHM	PC	9
11310130575	METAL OXIDE FILM RESISTOR 100	PC	1
11310210517	CARBON FILM RESISTOR 1K OHM	PC	11
11310210517	CARBON FILM RESISTOR 1K OHM	PC	10
11310210517	CARBON FILM RESISTOR 1K OHM	PC	10
11310230575	METAL OXIDE FILM RESISTOR 1K	PC	1
11310310167	METAL FILM RESISTOR 10K OHM	PC	1
11310310517	CARBON FILM RESISTOR 10K OHM	PC	10
11310310517	CARBON FILM RESISTOR 10K OHM	PC	7
11310310517	CARBON FILM RESISTOR 10K OHM	PC	5
11310340575	METAL OXIDE FILM RESISTOR 10K	PC	1
11310410517	CARBON FILM RESISTOR 100K OHM	PC	4
11310420512	CARBON FILM RESISTOR 100K OHM	PC	1
11310430575	METAL OXIDE FILM RESISTOR 100K	PC	1
11310510517	CARBON FILM RESISTOR 1M OHM	PC	1
11312030575	METAL OXIDE FILM RESISTOR 12	PC	1
11312040575	METAL OXIDE FILM RESISTOR 12	PC	1
11312210517	CARBON FILM RESISTOR 1.2K OHM	PC	6
11312310517	CARBON FILM RESISTOR 12K OHM	PC	3
11312420512	CARBON FILM RESISTOR 120K OHM	PC	1
11312940542	FUSING RESISTOR 1.2 OHM 2W	PC	1
11315210517	CARBON FILM RESISTOR 1.5K OHM	PC	2
11315310517	CARBON FILM RESISTOR 15K OHM	PC	3
11315340575	METAL OXIDE FILM RESISTOR 15K	PC	3
11315410517	CARBON FILM RESISTOR 150K OHM	PC	3
11315840575	METAL OXIDE FILM RESISTOR 0.15	PC	1
11315930575	METAL OXIDE FILM RESISTOR 1.5	PC	1
11318110517	CARBON FILM RESISTOR 180 OHM	PC	6
11318210517	CARBON FILM RESISTOR 1.8K OHM	PC	8
11318210517	CARBON FILM RESISTOR 1.8K OHM	PC	3
11318410517	CARBON FILM RESISTOR 180K OHM	PC	2
11320260575	METAL OXIDE FILM RESISTOR 2K	PC	1
11322110517	CARBON FILM RESISTOR 220 OHM	PC	3
11322130575	METAL OXIDE FILM RESISTOR 220	PC	1
11322210167	METAL FILM RESISTOR 2.2K OHM	PC	1
11322210517	CARBON FILM RESISTOR 2.2K OHM	PC	12
11322210517	CARBON FILM RESISTOR 2.2K OHM	PC	1
11322310517	CARBON FILM RESISTOR 22K OHM	PC	12
11322410517	CARBON FILM RESISTOR 220K OHM	PC	2
11322910517	CARBON FILM RESISTOR 2.2 OHM	PC	3
11322920512	CARBON FILM RESISTOR 2.2 OHM	PC	2
11322940575	METAL OXIDE FILM RESISTOR 2.2	PC	1
11322960551	WIRE WOUND CEMENT RESISTOR	PC	1
11327010517	CARBON FILM RESISTOR 27 OHM	PC	1
11327040575	METAL OXIDE FILM RESISTOR 27	PC	1

**MODEL NO.: CT-M5129STC Chassis type GT-821**  
**SYSTEM: PAL BG PLAYBACK AV IN / OUT CABLE TUNER**

Part Number	Description		Unit	Qty
11327110517	CARBON FILM RESISTOR 270 OHM	1/4W +-5%	PC	1
11327210517	CARBON FILM RESISTOR 2.7K OHM	1/4W +-5%	PC	1
11327220512	CARBON FILM RESISTOR 2.7K OHM	1/2W +-5%	PC	6
11327310517	CARBON FILM RESISTOR 27K OHM	1/4W +-5%	PC	3
11333010517	CARBON FILM RESISTOR 33 OHM	1/4W +-5%	PC	1
11333110517	CARBON FILM RESISTOR 330 OHM	1/4W +-5%	PC	4
11333210217	CARBON FILM RESISTOR 3.3K OHM	1/4W +-2%	PC	1
11333210517	CARBON FILM RESISTOR 3.3K OHM	1/4W +-5%	PC	3
11333310517	CARBON FILM RESISTOR 33K OHM	1/4W +-5%	PC	5
11333410517	CARBON FILM RESISTOR 330K OHM	1/4W +-5%	PC	1
11333430575	METAL OXIDE FILM RESISTOR 330K	OHM 1W +-5%	PC	1
11339050575	METAL OXIDE FILM RESISTOR 39	OHM 3W +-5%	PC	1
11339060575	METAL OXIDE FILM RESISTOR 39	OHM 5W +-5%	PC	1
11339110517	CARBON FILM RESISTOR 390 OHM	1/4W +-5%	PC	4
11339210517	CARBON FILM RESISTOR 3.9K OHM	1/4W +-5%	PC	2
11339310517	CARBON FILM RESISTOR 39K OHM	1/4W +-5%	PC	1
11347010517	CARBON FILM RESISTOR 47 OHM	1/4W +-5%	PC	4
11347110517	CARBON FILM RESISTOR 470 OHM	1/4W +-5%	PC	3
11347210517	CARBON FILM RESISTOR 4.7K OHM	1/4W +-5%	PC	7
11347310517	CARBON FILM RESISTOR 47K OHM	1/4W +-5%	PC	6
11347510517	CARBON FILM RESISTOR 4.7M OHM	1/4W +-5%	PC	1
11347910517	CARBON FILM RESISTOR 4.7 OHM	1/4W +-5%	PC	2
11347950575	METAL OXIDE FILM RESISTOR 4.7	OHM 3W +-5%	PC	1
11351110517	CARBON FILM RESISTOR 510 OHM	1/4W +-5%	PC	1
11356210517	CARBON FILM RESISTOR 5.6K OHM	1/4W +-5%	PC	3
11356521092	CARBON COMPOSITION RESISTOR	5.6M OHM 1/2W +-10%	PC	2
11362950575	METAL OXIDE FILM RESISTOR 6.2	OHM 3W +-5%	PC	1
11368110517	CARBON FILM RESISTOR 680 OHM	1/4W +-5%	PC	1
11368210217	CARBON FILM RESISTOR 6.8K OHM	1/4W +-2%	PC	1
11368210517	CARBON FILM RESISTOR 6.8K OHM	1/4W +-5%	PC	3
11368830542	FUSING RESISTOR 0.68 OHM 1W	+5%	PC	4
11375010517	CARBON FILM RESISTOR 75 OHM	1/4W +-5%	PC	4
11382010517	CARBON FILM RESISTOR 82 OHM	1/4W +-5%	PC	2
11382110517	CARBON FILM RESISTOR 820 OHM	1/4W +-5%	PC	2
11382210517	CARBON FILM RESISTOR 8.2K OHM	1/4W +-5%	PC	4
11382310517	CARBON FILM RESISTOR 82K OHM	1/4W +-5%	PC	1
11382410517	CARBON FILM RESISTOR 820K OHM	1/4W +-5%	PC	1
11421020001	THERMISTOR (NICHICON ZPB53 BL	200C)	PC	1
12310135060	CERAMIC CAP. 100 PF 50V +-10%	(SL TYPE) "SMART GOOD"	PC	1
12310235090	CERAMIC CAP. 0.001 MFD 50V	+10% (B TYPE)	PC	5
12310285010	CERAMIC CAP. 0.001 MFD 2KV	+10% MATSUSHITA	PC	1
12310337090	CERAMIC CAP. 0.01 MFD 50V +80	-20%	PC	11
12310337090	CERAMIC CAP. 0.01 MFD 50V +80	-20%	PC	1
12310427090	CERAMIC CAP. 0.1 MFD 25V +80	-20%	PC	9
12312135060	CERAMIC CAP. 120 PF 50V +-10%	(SL TYPE)	PC	3
12312255190	CERAMIC CAP. 0.0012 MFD 500V	+10% (B TYPE) MATSUSHITA	PC	1
12312285010	CERAMIC CAP. 0.0012 2KV +-10%		PC	1
12315034093	CERAMIC CAP. 15 PF 50V +-5%	(NPO)	PC	1
12315135060	CERAMIC CAP 150 PF 50V +-10%	(SL TYPE)	PC	1
12322034060	CERAMIC CAP. 22 PF 50V +-5%	(SL TYPE)	PC	4
12322135060	CERAMIC CAP. 220 PF 50V +-10%	(SL TYPE)	PC	6
12322155190	CERAMIC CAP. 220 PF 500V	+10% MATSUSHITA	PC	1
12322246650	CERAMIC CAP. 0.0022 MFD 400VAC	+20% ECKDNA222ME "MATSUSHITA"	PC	1
12322285010	CERAMIC CAP. 0.0022 MFD 2KV	+10% MATSUSHITA	PC	1
12322337090	CERAMIC CAP. 0.022 MFD 50V +80	-20%	PC	11

**MODEL NO.: CT-M5129STC Chassis type GT-821****SYSTEM: PAL BG PLAYBACK AV IN / OUT CABLE TUNER**

Part Number	Description	Unit	Qty
12322337090	CERAMIC CAP. 0.022 MFD 50V +80	-20%	PC 3
12327034060	CERAMIC CAP. 27 PF 50V +-5%	(SL-TYPE)	PC 2
12327034093	CERAMIC CAP. 27PF 50V +-5%	(NPO)	PC 2
12339034093	CERAMIC CAP. 39PF 50V +-5%	(NPO)	PC 2
12347235090	CERAMIC CAP. 0.0047 MFD 50V	+-10% (B TYPE)	PC 2
12347255090	CERAMIC CAP. 0.0047 MFD 500V	+-10% (B TYPE)	PC 3
12347255290	CERAMIC CAP. 0.0047 MFD 500V	+-10% (B TYPE) SMALL SIZE	PC 3
12350934093	CERAMIC CAP. 5 PF 50V +-5%	(NPO)	PC 1
12368135090	CERAMIC CAP. 680 PF 50V +-10%	(B TYPE)	PC 1
12382185010	CERAMIC CAP. 820 PF 2KV +-10%	(SL TYPE) MATSUSHITA	PC 1
12536112011	POLYSTYRENE CAP. 360PF 125V	+5%	PC 1
12539112011	POLYSTYRENE CAP. 390 PF 125V	+5%	PC 1
12610207101	MYLAR CAP. 0.001 MFD 50V +-10%		PC 3
12610407101	MYLAR CAP. 0.1 MFD 50V +-10%		PC 10
12610407101	MYLAR CAP. 0.1 MFD 50V +-10%		PC 3
12610410131	POLYPROPYLENE CAP. 0.1 MFD	100V +-10%	PC 1
12622207101	MYLAR CAP. 0.0022 MFD 50V	+10%	PC 2
12622216141	METALIZED POLYPROPYLENE CAP.	0.0022 MFD 1600V +-10%	PC 1
12622307101	MYLAR CAP. 0.022 MFD 50V +-10%		PC 5
12622407101	MYLAR CAP 0.22 MFD 50V +-10%		PC 3
12622407101	MYLAR CAP 0.22 MFD 50V +-10%		PC 2
12627207031	POLYPROPYLENE CAP. 0.0027 MFD	50V +-5%	PC 1
12633216141	METALIZED POLYPROPYLENE CAP.	0.0033 MFD 1600V +-10%	PC 1
12633307101	MYLAR CAP. 0.033 MFD 50V +-10%		PC 1
12633407101	MYLAR CAP. 0.33 MFD 50V +-10%		PC 2
12647207101	MYLAR CAP. 0.0047 MFD 50V	+-10%	PC 2
12647307101	MYLAR CAP. 0.047 MFD 50V +-10%		PC 2
12647322241	METALIZED POLYPROPYLENE CAP.	0.047 MFD 275V +-20% "OKAYA"	PC 1
12647420131	POLYPROPYLENE CAP 0.47 MFD	200V +-10%	PC 1
12647422241	METALIZED POLYPROPYLENE CAP.	0.47 MFD 275VAC +-20% "OKAYA"	PC 1
12710507203	ELECT. CAP. 1 MFD 50V +-20%		PC 5
12710513203	ELECT. CAP. 1 MFD 160V	+20%	PC 1
12710604203	ELECT. CAP. 10 MFD 16V +-20%		PC 9
12710604203	ELECT. CAP. 10 MFD 16V +-20%		PC 12
12710610403	ELECT CAP. 10 MFD 100V +-20%	105øC	PC 1
12710704203	ELECT. CAP. 100 MFD 16V +-20%		PC 8
12710706203	ELECT. CAP. 100 MFD 35V +-20%		PC 2
12710713203	ELECT. CAP. 100 MFD 160V +-20%	"NICHICON"	PC 1
12710804203	ELECT. CAP. 1000 MFD 16V +-20%		PC 1
12710805203	ELECT. CAP. 1000 MFD 25V +-20%		PC 1
12715740203	ELECT. CAP. 150 MFD 400V +-20%	(25 x 30MM)	PC 1
12722504223	ELECT. CAP. BIPOLAR 2.2MFD 16V	+20%	PC 2
12722507203	ELECT. CAP 2.2 MFD 50V +-20%		PC 11
12722604203	ELECT. CAP. 22 MFD 16V +-20%		PC 1
12722704203	ELECT. CAP. 220 MFD 16V +-20%		PC 3
12722706203	ELECT. CAP. 220 MFD 35V +-20%		PC 3
12722805203	ELECT. CAP. 2200 MFD 25V +-20%		PC 2
12733507105	ELECT CAP. 3.3UF 50V +-10%	(TIME CONSTANT)	PC 1
12733604203	ELECT. CAP. 33 MFD 16V +-20%		PC 2
12733625203	ELECT CAP. 33 MFD 250V +-20%		PC 1
12747407203	ELECT. CAP. 0.47 MFD 50V +-20%		PC 1
12747507203	ELECT CAP 4.7 MED 50V		PC 7
12747604203	ELECT. CAP. 47 MFD 16V +-20%		PC 3
12747609407	ELECT CAP. 47 MFD 63V +-20%	105øC "NICHICON"	PC 1
12747613203	ELECT. CAP. 47 MFD 160V +-20%		PC 1

**MODEL NO.: CT-M5129STC Chassis type GT-821****SYSTEM: PAL BG PLAYBACK AV IN / OUT CABLE TUNER**

Part Number	Description	Unit	Qty
12747704203	ELECT. CAP. 470 MFD 16V +-20%	PC	8
13013414801	SILICON DIODE IN4148	PC	7
13013414801	SILICON DIODE IN4148	PC	11
13024080950	VERIABLE CAPACITANCE DIODE	PC	2
	BB809		
13031002200	RECTIFIER DIODE RG2 SANKEN	PC	1
13031015600	BRIDGE RECTIFIER RB156 SANKEN	PC	1
13031154560	RECTIFIER DIODE 1R5JH45	PC	1
13031440600	RECTIFIER DIODE ERB44-06 FUJI	PC	1
13031529500	RECTIFIER DIODE S5295G TOSHIBA	PC	9
13041005101	ZENER DIODE 5.1V 1/2W +-5%	PC	1
13041008201	ZENER DIODE 8.2V	PC	1
13041010001	ZENER DIODE 10V 1/2W	PC	1
13041057400	ZENER DIODE UPC 574J NEC	PC	1
13041109101	ZENER DIODE 9.1V	PC	1
13042212090	ZENER DIODE 12V 1W +-5%	PC	1
13051204400	LED 3MM RED 204HDC	PC	1
13121101318	TRANSISTOR 2SA1013 (R) TOSHIBA	PC	1
13121101500	TRANSISTOR 2SA1015 TOSHIBA	PC	4
13122077420	TRANSISTOR 2SB774/Q/R/S	PC	1
	MATSUSHITA		
13123180900	TRANSISTOR 2SC1809 ROHM	PC	1
13123181525	TRANSISTOR 2SC1815 TOSHIBA	PC	9
13123181525	TRANSISTOR 2SC1815 TOSHIBA	PC	5
13123223000	NPN-TR 2SC2230A-Y (TOSHI) TO92	PC	1
	VCE=180V IC=.1A HFE=120-240		
13123233530	TRANSISTOR 2SC2335 L/K NEC	PC	1
13123248200	TRANSISTOR 2SC2482 TOSHIBA	PC	4
13124176100	TRANSISTOR 2SD1761(E) ROHM	PC	1
13124249813	TRANSISTOR 2SD2498(M) TOSHIBA	PC	1
13124249913	TRANSISTOR 2SD2499(M) TOSHIBA	PC	1
13146236900	TRANSISTOR PH2369 PHILIPS	PC	1
13310035233	I.C. CTV350S.GW2 PHILIPS	PC	1
13310350433	I.C. TDA3504 PHILIPS	PC	1
13310385733	IC TDA3857 PHILIPS	PC	1
13310450533	I.C. TDA4505E PHILIPS	PC	1
13310451033	PHILIPS IC TDA4510	PC	1
13310841633	I.C. TDA8416 PHILIPS	PC	1
13310862814	IC TA8628N TOSHIBA	PC	1
13320365333	I.C. TDA3653B PHILIPS	PC	1
13320444516	I.C. LA4445 (SANYO)	PC	1
13320780531	I.C. L7805CV SGS	PC	1
13320781231	IC L7812CV SGS-THOMSON	PC	1
13330424133	I.C. 74HCT241N PHILIPS	PC	1
13330511431	I.C. TEA5114A SGS	PC	1
13650000200	REMOTE RECEIVER (HC-SZ02)	PC	1
13710000031	CRYSTAL 10 MHZ HOORAY	PC	2
13788672320	CRYSTAL 8.86 MHz KDS	PC	1
14610000213	TACT SWITCH KSM0634A HDK	PC	4
14610000614	POWER SWITCH PS5E-B	PC	1
	"CHINA LANDMARK"		
14614500000	TACT SWITCH TM116E UNITRONIC	PC	3
16010100108	PIN CONNECTOR 1 PIN PLUG	PC	3
	STRAIGHT		
16010225527	PIN CONNECTOR 2 PINS PLUG	PC	3
	STRAIGHT (UL) (S.H.S)		
16010280508	PIN CONNECTOR 2 PIN PLUG	PC	1
	STRAIGHT		
16010325527	PIN CONNECTOR 3 PINS PLUG	PC	9
16010380508	PIN CONNECTOR 3 PIN PLUG	PC	1
	STRAIGHT		
16010425527	PIN CONNECTOR 4 PINS PLUG	PC	2
	(SHS)		
16010480508	PIN CONNECTOR 4 PIN PLUG	PC	1
	STRAIGHT		

**MODEL NO.: CT-M5129STC Chassis type GT-821**  
**SYSTEM: PAL BG PLAYBACK AV IN / OUT CABLE TUNER**

Part Number	Description	Unit	Qty
16010525527	PIN CONNECTOR 5 PINS WAFER 2.5 PITCH	PC	1
16010625527	PIN CONNECTOR 6 PINS WAFER (SHS) S11-W	PC	1
16147100200	RCA JACK 3 PIN BLACK JPJ1022-01-010 "HOSIDEN"	PC	1
16147300300	RCA JACK 3 PIN YELLOW SC-8.4-6A "HONG YIP"	PC	1
16147320400	RCA JACK 3 PIN UIC-032-04AR RED "UNITRONIC"	PC	1
16154000401	CRT SOCKET ISH-01 IN CHANG	PC	1
16168370222	21 PIN SOCKET	PC	1
1664630234E	SPEAKER 2" X 3-1/2" 16 OHM 3W K.T.	PC	2
17262000740	UL 1007 TOP COAT WIRE #20 70MM BLACK 5 X 5 MM	PC	2
17262001240	UL 1007 TOP COAT WIRE AWG 20 120MM BLACK 10 X 10 MM	PC	1
17262001440	UL 1007 TOP COAT WIRE AWG 20 140MM BLACK 10 X 10 MM	PC	1
17262001640	UL 1007 TOP COAT WIRE AWG 20 160MM BLACK 10 X 10 MM	PC	1
17262600642	UL 1007 TOP COAT WIRE AWG 26 60MM RED 10 X 10 MM	PC	1
17262600840	UL 1007 TOP COAT WIRE AWG 26 80MM BLACK 10 X 10 MM	PC	3
17262600840	UL 1007 TOP COAT WIRE AWG 26 80MM BLACK 10 X 10 MM	PC	0
17262601244	UL 1007 TOP COAT WIRE AWG 26 120MM YELLOW 10 X 10 MM	PC	1
17262601440	UL 1007 TOP COAT WIRE AWG 26 140MM BLACK 10 X 10 MM	PC	1
17262601442	UL 1007 TOP COAT WIRE AWG 26 140MM RED 10 X 10 MM	PC	1
17262602245	UL 1007 TOP COAT WIRE AWG 26 220MM PINK 10 X 10 MM	PC	1
17262602246	UL 1007 TOP COAT WIRE AWG 26 220MM BLUE 10 X 10 MM	PC	2
17272600099	BARE WIRE 54MM	M	6.1
17272600099	BARE WIRE 54MM	M	0
17272600099	BARE WIRE 54MM	M	0
17272600099	BARE WIRE 54MM	M	0
17272600099	BARE WIRE 54MM	M	0
17272600099	BARE WIRE 54MM	M	0
17283012099	FLAT BRIDED WIRE	M	1.2
17362201430	SINGLE SHIELD WIRE AWG 26 140MM BLACK	PC	1
17461101750	DOUBLE SHIELD WIRE AWG 26 180MM BLACK	PC	1
17765505302	2 PIN FLAT CABLE WIRE AWG 26 50MM	PC	1
17900101000	OIL SLEEVING 1 mm DIA.	M	0.1
17900101000	OIL SLEEVING 1 mm DIA.	M	0.1
17900101000	OIL SLEEVING 1 mm DIA.	M	0.1
17900101000	OIL SLEEVING 1 mm DIA.	M	0
17900102000	OIL SLEEVING 2MM DIA.	PC	0.1
17910500000	UL PVC TUBE 5mm DIA	M	0.2
17910500000	UL PVC TUBE 5mm DIA	M	1
17910730000	UL PVC TUBE 7.3MM DIA.	PC	0.6
17911050000	UL PVC TUBE 11MM DIA.	M	0.1
17940308000	SHRINKABLE TUBE	PC	0.2
17940503000	5 mm DIA SHRINKABLE TUBE	M.	0.1
18223315003	FUSE T3.15A 250V	PC	1
190821B0108	FRONT AV STEREO IN P.C.B. (081297)	PC	1
19088200400	P.C. BOARD CRT (150395)	PC	1
19094200201	MAIN P.C.B. BOARD (010598) L/SENSOR,R/LED	PC	1
19094200309	NICAM/STEREO P.C.B. (260897)	PC	1
19110003009	1 PIN SOCKET ASSM'Y L=300MM	PC	1
19110101607	1 PIN DOUBLE INSOLATION WIRE AWG 18 L=340MM BLUE	PC	1
19110101707	1 PIN DOUBLE INSOLATION WIRE AWG 18 L=340MM BROWN	PC	1
19120004409	2 PIN SOCKET ASSM'Y L=440MM	PC	1
19120101107	2 PIN SOCKET ASSM'Y L=440MM	PC	1
19120104007	2 PIN SOCKET ASS'Y L=450MM #26 UL1185 W/SHIELDING CABLE	PC	1
19130004009	3 PIN SOCKET ASSM'Y (PIN 1 L= 460MM, PIN 2,3 L=400MM)	PC	1
19130004009	3 PIN SOCKET ASSM'Y (PIN 1 L= 460MM, PIN 2,3 L=400MM)	PC	0
19130004009	3 PIN SOCKET ASSM'Y (PIN 1 L= 460MM, PIN 2,3 L=400MM)	PC	0
19130100507	3 PINS SOCKET ASS'Y (2 WIRE) L=560MM	PC	1



**MODEL NO.: CT-M5129STC Chassis type GT-821****SYSTEM: PAL BG PLAYBACK AV IN / OUT CABLE TUNER**

Part Number	Description		Unit	Qty
19130105207	3 PIN L=450MM W/SHIELD CABLE	#26 UL1007 (GND,WHITE,RED)	PC	1
19130105307	3 PIN L=450MM W/SHIELD CABLE	#26 UL2547 (RED,WHITE GND)	PC	1
19130120507	3 PINS SOCKET ASS'Y L=100MM		PC	1
19130120707	3 PIN SOCKET ASS'Y L=200MM		PC	1
19140120107	4 PINS SOCKET ASS'Y L=60MM		PC	1
19150004809	5 PIN SOCKET ASSM'Y L=480MM		PC	1
19150004809	5 PIN SOCKET ASSM'Y L=480MM		PC	0
19150004809	5 PIN SOCKET ASSM'Y L=480MM		PC	0
19150004809	5 PIN SOCKET ASSM'Y L=480MM		PC	0
19150004809	5 PIN SOCKET ASSM'Y L=480MM		PC	0
50430500610	MACHINE SCREW 3 X 6 B/M	(WHITE)	PC	4
51730331210	SELF-TAPPING SCREW 3 X 12 W/A	W/H=7MM (HARDEN)	PC	3
54002003001	EYELET 2 X 3 MM		PC	14
54002003001	EYELET 2 X 3 MM		PC	0
58010100400	STAND OFF TWIST TIE #ST-3		PC	1
58010126101	CABLE TIE L=100MM		PC	29
58010126101	CABLE TIE L=100MM		PC	0
63011551200	FIBRE WASHER 11 X 5.5 X 1.2 mm		PC	4
74488130100	SPRING FOR C.R.T. MOUNTING 5.2	X 42 X 0.6MM	PC	1
74606310100	TEST PIN:TOTAL LENGTH 18.6mm	THK:0.8mm	PC	2
74606310101	AC LINE CORD PIN		PC	4
75006310100	SOLDERING LUG LEG:8X4MM		PC	3
76668680100	FUSE HOLDER		PC	2
77992130100	HEAT SINK FOR NICAM		PC	1
77993290202	IRON HEAT SINK		PC	1
78188200102	ALUMINIUM HEAT SINK (B)		PC	1
78194210102	HEAT SINK (A)	®®-OUT DATE---	PC	1
78194210500	HEAT SINK (C) ASS'Y		PC	1
78388130602	SHIELD CAN COVER		PC	1
78388131301	SHIELD CAN		PC	1
78388280101	NICAM BOARD SHIELD PLATE		PC	1
92988130100	LED HOLDER BKT		PC	1
93888200100	SECAM BOARD HOLDER		PC	4

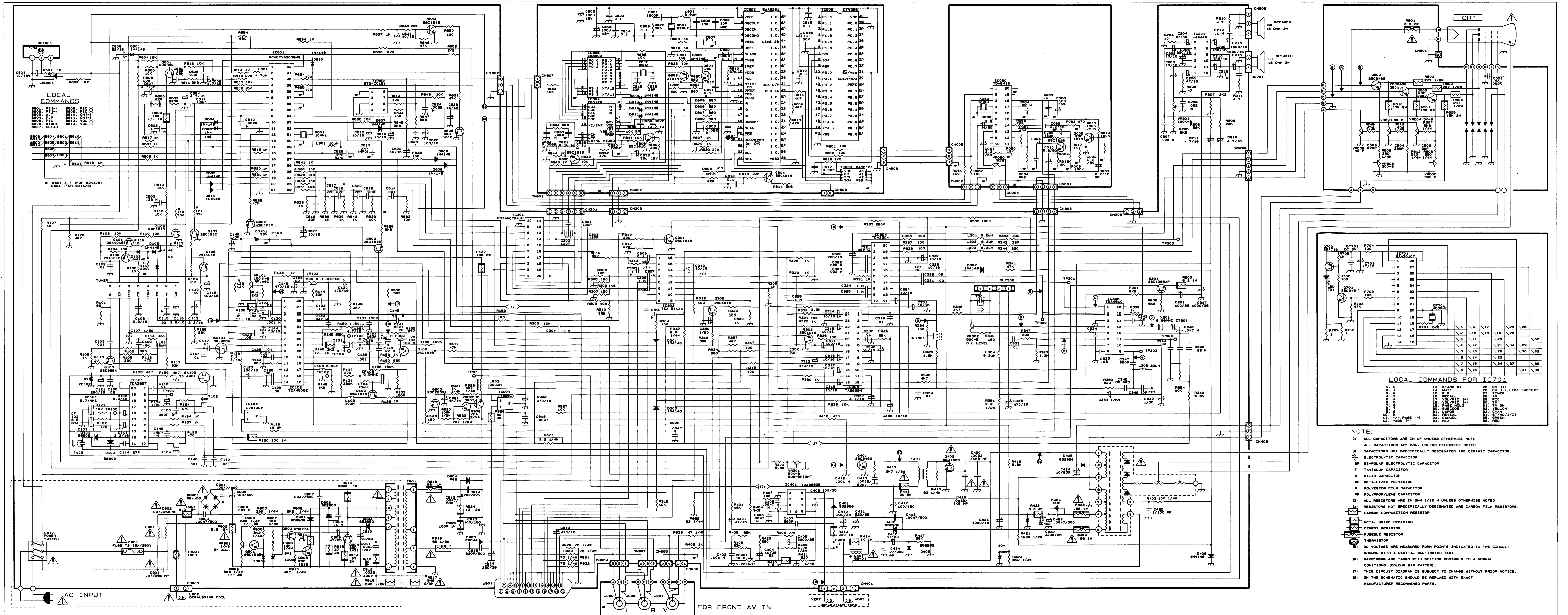

IC	Pin	Signal	IC	Pin	Signal	IC	Pin	Signal	IC	Pin	Signal
IC601	1	VTUR	IC801	48	IC	IC802	1	Y	IC701	2	Y
IC601	2	V00	IC801	49	IC	IC802	2	P1.0	IC701	3	P1.0
IC601	3	V01	IC801	50	IC	IC802	3	P1.1	IC701	4	P1.1
IC601	4	V02	IC801	51	IC	IC802	4	P1.2	IC701	5	P1.2
IC601	5	V03	IC801	52	IC	IC802	5	P1.3	IC701	6	P1.3
IC601	6	V04	IC801	53	IC	IC802	6	P1.4	IC701	7	P1.4
IC601	7	V05	IC801	54	IC	IC802	7	P1.5	IC701	8	P1.5
IC601	8	V06	IC801	55	IC	IC802	8	P1.6	IC701	9	P1.6
IC601	9	V07	IC801	56	IC	IC802	9	P1.7	IC701	10	P1.7
IC601	10	V08	IC801	57	IC	IC802	10	P1.8	IC701	11	P1.8
IC601	11	V09	IC801	58	IC	IC802	11	P1.9	IC701	12	P1.9
IC601	12	V10	IC801	59	IC	IC802	12	P1.0	IC701	13	P1.0
IC601	13	V11	IC801	60	IC	IC802	13	P1.1	IC701	14	P1.1
IC601	14	V12	IC801	61	IC	IC802	14	P1.2	IC701	15	P1.2
IC601	15	V13	IC801	62	IC	IC802	15	P1.3	IC701	16	P1.3
IC601	16	V14	IC801	63	IC	IC802	16	P1.4	IC701	17	P1.4
IC601	17	V15	IC801	64	IC	IC802	17	P1.5	IC701	18	P1.5
IC601	18	V16	IC801	65	IC	IC802	18	P1.6	IC701	19	P1.6
IC601	19	V17	IC801	66	IC	IC802	19	P1.7	IC701	20	P1.7
IC601	20	V18	IC801	67	IC	IC802	20	P1.8	IC701	21	P1.8
IC601	21	V19	IC801	68	IC	IC802	21	P1.9	IC701	22	P1.9

**LOCAL COMMANDS FOR IC701**

NO.	SYMBOL	IC	IC701 PIN
1	Vsync	IC701	2
2	Hsync	IC701	3
3	CLOCK	IC701	11
4	LINE 50	IC701	12
5	LINE 1	IC701	13
6	LINE 2	IC701	14
7	LINE 3	IC701	15
8	LINE 4	IC701	16
9	LINE 5	IC701	17
10	LINE 6	IC701	18
11	LINE 7	IC701	19
12	LINE 8	IC701	20
13	LINE 9	IC701	21
14	LINE 10	IC701	22

**NOTE:**

- ALL CAPACITORS ARE IN  $\mu\text{F}$  UNLESS OTHERWISE NOTED
- ALL CAPACITORS ARE 50V UNLESS OTHERWISE NOTED
- RESISTORS NOT SPECIFICALLY DESIGNATED ARE CERAMIC CAPACITORS
- ELECTROLYTIC CAPACITORS
- BY-PASS ELECTROLYTIC CAPACITORS
- TANTALUM CAPACITORS
- WETTED FILM CAPACITORS
- METALIZED POLYMER CAPACITORS
- POLYPROPYLENE CAPACITORS
- POLYESTER FILM CAPACITORS
- ALL RESISTORS ARE IN OHMS UNLESS OTHERWISE NOTED
- RESISTORS NOT SPECIFICALLY DESIGNATED ARE CARBON FILM RESISTORS
- CARBON COMPOSITION RESISTORS
 METAL OXIDE RESISTOR |- CEMENT RESISTOR
- FUSIBLE RESISTOR
- THEMISTOR
- DC VOLTAGE ARE MEASURED FROM POINTS INDICATED TO THE CIRCUIT
- GROUND WITH A DIGITAL MULTIMETER TEST.
- WAVEFORMS ARE TAKEN WITH RESUME CONTROLS TO A NORMAL
- CONDITIONS (COLOR BAR PATTERN).
- THIS CIRCUIT DIAGRAM IS SUBJECT TO CHANGE WITHOUT PRIOR NOTICE.
- ON THE SCHEMATIC SHOULD BE REPLACED WITH EXACT MANUFACTURER RECOMMENDED PARTS.

**Legend:** C (Ceramic), E (Electrolytic), P (Polyester), Y (Tantalum), W (Wetted film), M (Metalized polymer), P (Polypropylene), C (Carbon composition), MO (Metal oxide), C (Cement), F (Fusible), T (Thermistor), V (DC voltage), W (Waveform), S (Safety critical device).

**FOR FRONT AV IN**

ART-VIDEO ENGINEERING LTD.  
115-115 (WILLOW) DRIVE  
SCHEMATIC DIAGRAM  
PART NO. 100-201-0001 P.17  
BA5000-25-A/S (REV. 10)